

VELCO ENVIRONMENTAL GUIDANCE MANUAL



Committed to Environmental Excellence



May 2012

Revision Sheet for VELCO Environmental Guidance Manual

| Rev. No. | Date | Description |
|-----------------|-------------|--------------------------------|
| 1 | 2008 | Initial Plan |
| 2 | 2009 | Modified Seed Mixes |
| 3 | 2011 | Updated Typical |
| 4 | 2012 | Added Stream Crossing Guidance |

TABLE of CONTENTS

| | |
|--|-----------|
| 1.0 Purpose | |
| 1.1 Document Owner and Contact Information | 1 |
| 1.2 Background | 1 |
| 2.0 Terms and Definitions | 1 |
| 3.0 Roles and Responsibilities | 4 |
| 3.1 Permits and Regulatory Compliance | 4 |
| 3.2 Environmental and Safety Training | 4 |
| 3.3 Executing the Work | 4 |
| 4.0 Best Management Practices | 5 |
| 4.1 ROW Access | 5 |
| 4.1.1 Construction Projects | 5 |
| 4.1.2 Maintenance | 5 |
| 4.1.3 Construction Entrances, Culvert Replacement, & Stormwater Control | 5 |
| 4.1.4 Upland Access | 6 |
| 4.1.5 Frozen or Dry Conditions | 6 |
| 4.1.6 Construction Mats | 6 |
| 4.1.7 Realignment of Mats | 6 |
| 4.1.8 Stream Crossings | 7 |
| 4.2 Work Activities | 7 |
| 4.2.1 Materials | 7 |
| 4.2.2 Erosion Controls | 7 |
| 4.2.3 Grading Activities | 8 |
| 4.2.5 Dewatering | 8 |
| 4.2.4 Soil Handling Activities | 8 |
| 4.2.6 Work at Structures in Wetlands | 9 |
| 4.2.7 Work at Other Sensitive Areas | 9 |
| 4.2.8 Soil Disturbance | 10 |
| 4.3 Field Refueling and Equipment Maintenance | 10 |
| 4.3.1 Releases of OHM | 10 |
| 4.4 Restoration | 11 |
| 4.4.1 Disturbed Areas | 11 |
| 4.4.2 Improved Areas | 11 |
| 4.4.3 Construction Mats/Temporary Bridges | 11 |
| 4.4.4 Erosion Controls | 12 |
| 4.4.5 Work Sites and Material Storage & Staging Areas | 12 |
| 4.5 Summary of Key Construction Best Management Practices | 12 |
| 5.0 Typical Best Management Practice Drawings | 12 |
| Attachment A - ENVIRONMENTAL POLICIES AND PROCEDURES | |
| A-1 - Incident Reporting Procedure | |
| A-1.1 - Spill Response and Cleanup Procedure | |
| A-2 - Dry Evaluation Procedure | |
| A-3 - Pre-Construction "Look-Ahead" Procedure | |
| A-4 - Plan Amendment Procedure | |
| A-5 - Dewatering Plan | |
| A-6 – Corridor Access Review Procedure | |
| A-7 – Unanticipated Discovery Response Procedure | |
| Attachment B - ENVIRONMENTAL INSPECTIONS AND REPORTING | |
| B-1 - Environmental Inspection and Compliance Report | |
| B-2 - Environmental Incident Report | |
| B-3 - Environmental Change Review Form | |
| Attachment C - TYPICAL BEST MANAGEMENT PRACTICE DRAWINGS | |
| Attachment D - RECOMMENDED SEED MIXES | |
| Attachment E – RELEVANT BMPs | |
| E-1 – Stream Crossing Guidance | |
| E-2 – Bat BMPs | |

1.0 PURPOSE

The purpose of this document, the *VELCO Environmental Guidance Manual* (VEGM), is to provide Best Management Practices (BMPs) to VELCO staff, consultants, contractors and subcontractors to avoid or minimize impacts to natural and cultural resources during work within new and existing electrical transmission right-of-ways (ROWs) and substations.

The BMPs included in the VEGM should be consistently followed by all personnel accessing VELCO's substations and ROWs for maintenance, inspections, and construction purposes. This document shall be utilized as a supplement to VELCO's Transmission Vegetation Management Plan which is administered by the VELCO ROW Maintenance Department.

1.1 Document Owner and Contact Information

The VELCO Environmental Team is the owner of this document and will help ensure adherence to BMPs contained herein. Additionally, the Environmental Team will be responsible for updating this manual on a routine basis. Contact the Environmental Team if there are any questions regarding the information contained in this manual.

ATTN: Brian Connaughton – Transmission Services Manager
Vermont Electric Power Company
366 Pinnacle Ridge Road
Rutland, VT 05701
Office: 802-770-6227

1.2 Background

VELCO constructs, operates, and maintains electric transmission and fiber optic lines and substations throughout Vermont. In order to perform this work, access is required onto company properties, ROWs and private property for planning, construction, inspections, and maintenance activities. Many existing and proposed electrical transmission lines and substations are located within, or proximate to, sensitive environmental areas such as wetlands, rivers, streams, and archeological sites.

2.0 TERMS AND DEFINITIONS

Approved Access Route: An approved and designated route for a Construction Project utilized to transport personnel, equipment, and material from an existing public way to a ROW or substation. Approved Access Routes will be shown on Project Plans and may be marked with flagging and signs. Roads and paths not identified on Project Plans should not be used until appropriate environmental/archeological review is performed and approval for use is issued by the VELCO Environmental Team.

USACE: Army Corps of Engineers - Federal agency that regulates wetland impacts. Among other items, the USACE regulates the use of fill and construction mats within wetlands.

Archeological Site: An area where important cultural resources have been identified. Special work conditions often apply to these areas. Caution must be exercised when working in these

areas to ensure that field and construction equipment operate in a manner to avoid ground disturbance.

BMP: BMPS or Best Management Practices are specific field actions implemented in order to avoid or mitigate impacts to Protected Resources.

Clearing: The cutting, windrowing, and removal of vegetation by hand or mechanical means.

Common Backfill: Unless outlined in project-specific specifications, common backfill is defined as previously excavated soil deemed suitable for backfill material.

Construction Project(s): All field work that is not classified as Maintenance.

Construction Mats: Often referred to as “swamp mats”, construction mats typically consist of wood or plastic material designed to support construction equipment in wetlands or areas of unstable soil. The use of construction mats in wetlands may be regulated.

Dry Evaluation: An evaluation performed to identify Work Areas within wetlands that may become dry enough to work in without utilizing temporary fill (construction mats) and without adversely affecting the wetland. Prior to the initiation of Work, a dry-evaluation must be performed for each wetland in which Work is intended without the use of construction mats.

ECC: Erosion Control Coordinator - Individual responsible for ensuring the proper deployment of erosion control measures and conducting routine inspections and associated reporting. Contact information for the ECC must be submitted to the VELCO Environmental Team prior to the performance of construction activities on a Construction Project.

Environmental Monitoring Report: A report prepared by either VELCO or its consultants documenting project-related activities, including permit compliance, erosion control measures, archeological mitigation measures, and the proper implementation and use of company policies and procedures. This report also includes recommendations to avoid and/or mitigate impacts to sensitive areas. An example of a monitoring report suggested for use by VELCO is attached in Attachment B – *Environmental Inspections and Reporting*.

EPSCP: Erosion Prevention and Sedimentation Control Plan - A project-specific document summarizing erosion control measures for a Construction Project.

Maintenance: Work activity involving the inspection, reconnaissance, evaluation, repair, and maintenance (without substantially enlarging) of existing transmission line structures and facilities and substations. For the purpose of this manual, Maintenance also includes the following: 1) emergency repair work; 2) field work performed in advance of the issuance of a Certificate of Public Good (e.g., § 248 studies), including but not limited to engineering surveys, environmental surveys and field studies, archaeological surveys and field studies, geotechnical studies, including soil borings and engineering studies.

OHM: Oil and Hazardous Material – Common OHM encountered during Work includes gasoline, hydraulic oil and diesel fuel.

On-site Plan Coordinator (OSPC): Individual responsible for ensuring the proper deployment of erosion control measures and conducting routine inspections and associated reporting. Contact information for the OSPC must be submitted to the VELCO Environmental Team prior to the performance of construction activities on a Construction Project. Other responsibilities include site plan updates, edits, and documenting any modifications to new areas of soil disturbance, equipment access routes, and alterations to proposed erosion control measures.

Pre-Construction Look Ahead: Pre-construction inspection and review performed at all Work Areas prior to the performance of Work. The purpose of the review is to identify and discuss specific permit conditions and review special work practices, Project Plans, impact mitigation measures, restoration activities, etc. At a minimum, this inspection shall be performed by a group consisting of a member of the VELCO Environmental Team/Environmental Consultant, a Work Crew Supervisor, and a Field Coordinator.

Project Plans: Plans and drawings that form part of a permit or are based on a permit that depict regulated areas, Protected Resources and Approved Access Routes.

Protected Resource: Environmentally sensitive areas, including wetlands, rivers/streams, shorelines, RTE, RINA. Protected Resource also includes Archaeological Sites.

PSB: Public Service Board

RINA: Rare and Irreplaceable Natural Area - Area of unique or rare habitat of special importance or significance. These areas are often wetlands containing populations of threatened or endangered species.

Regulated Wetland Area: Wetland areas subject to federal and/or state regulations, including the associated 50-foot buffer zone for Class II wetlands.

RTE: Rare, Threatened or Endangered Species – Special species which are protected by state and/or federal regulations.

Right of Way (ROW): A corridor of land where VELCO has legal rights to construct, operate, and maintain an electrical transmission line and associated equipment.

Select Backfill: Unless outlined in project-specific specifications, select backfill is defined as washed stone and/or sandy gravel material deemed suitable for backfill.

VTANR: Vermont Agency of Natural Resources – State agency that regulates impacts to wetlands, buffer zones, rare species, special habitats, etc. Also regulates erosion control practices.

Work: Field work associated with a Construction Project or Maintenance.

Work Crew(s): The workers, supervisors and managers executing and responsible for executing the Work. This includes VELCO Associates and line crews, contractors, subcontractors, and consultants.

Work Area: Includes all areas where structures are to be set, access roads, whether permanent or temporary (including on and off ROW), staging areas, lay-down areas, substations and all other areas where Work Crews may store, stage, park and/or operate equipment or vehicles for the purpose of executing the work.

3.0 ROLES AND RESPONSIBILITIES

3.1 Permits and Regulatory Compliance

The Environmental Team will evaluate the Work to determine if permits or other agency approvals are required. Although permits are often required for Construction Projects, permit authorizations may also be necessary for Maintenance activities depending on the nature of the work. The permits required for Work depends on the scope of the Work and the resources (e.g. wetlands, streams, etc.) to be impacted. Larger transmission and substation projects typically require 1) a Section 404 permit from the USACE; and, 2) a State Wetland Permit, a 401 Water Quality Certificate, and a Storm Water Discharge Construction Permit from the VTANR. If the PSB has issued a Certificate of Public Good, other conditions may apply.

3.2 Environmental and Safety Training

Prior to the performance of Work, all personnel shall complete environmental training, which will be provided by the Environmental Team. Trainings for each Construction Project are unique, and as such, the Environmental Team will provide project-specific trainings for each project. Personnel conducting Maintenance should complete general environmental compliance training on an annual basis.

Training will inform Work Crews of the rules, regulations, procedures, and BMPs that must be followed while performing Work. The training will provide detailed information on project-specific permit conditions and Project Plans. At the request of either the Environmental Team or the Work Crews, additional training may be held throughout the performance of the Work to reinforce previous training topics or to provide new or additional information (e.g., new conditions as a result of a permit modification or guidance from a regulatory agency).

3.3 Executing the Work

It is the responsibility of Work Crews to execute Work in accordance with applicable permits, Project Plans, and BMPs as outlined in this manual. Additionally, Work Crews shall follow the STAR protocol in the event questions or concerns arise during the execution of Work.

The STAR protocol is:

- Stop
- Think
- Act, and
- Review

4.0 BEST MANAGEMENT PRACTICES

4.1 ROW Access

4.1.1 Construction Projects

For Construction Projects, Work Crews shall access the ROW in accordance with the Project Plans using Approved Access Routes. Many existing access routes such as snowmobile and ATV trails, farm roads, etc. transverse Protected Resources; therefore, Work Crews shall not utilize these routes unless they are mapped on the Project Plans. If such routes are needed for access and are not on the Plans, then the VELCO Environmental Team must be notified so that the appropriate environmental reviews can be performed and necessary agency authorizations obtained.

4.1.2 Maintenance

For routine Maintenance activities, prior review and approval of off-ROW access routes is not typically required; however, consultation with the Environmental Team is recommended. When selecting access routes to perform maintenance work, crews should adhere to the Corridor Access Road Review Procedure found in *Attachment A – Environmental Policies and Procedures*.

4.1.3 Construction Entrances, Culvert Replacement & Stormwater Control

For Construction Projects, a construction entrance (see Attachment C-Typical Best Management Practices) is typically required when accessing the ROW via a public way where equipment could track loose soil onto a paved roadway. Construction entrances should be constructed of clean crushed stone placed on geotextile fabric, which should extend at least five (5) feet beyond the edge of the stone. Once work is complete, the stone should be removed (depending on future access requirements) and the area restored. A construction entrance is not typically required for Maintenance Work; however, maintenance crews should consult with the Environmental Team if the following conditions exist for the purpose of evaluating the need for a construction entrance:

- Access for maintenance will be via a road with moderate to high traffic volume;
- Access is via a paved road;
- Field conditions are adverse (e.g., extremely wet, extremely muddy); or
- Maintenance Work is planned for an extended period.

Maintenance of existing access routes (both off-ROW and in-ROW) is often required for safe and efficient equipment access and operation. Maintenance may include grading of rutted areas, deployment of crushed stone, and when permitted, the repair or replacement of damaged or otherwise unsuitable culverts. Special precautions must be taken when replacing or repairing existing culverts to protect adjacent waterways and/or wetlands. Work on culverts should not be performed during extremely wet periods and/or periods of heavy flow through the culvert.

Before and during use of an access, erosion controls and storm water conveyance measures should be installed along the roadway to prevent soil transport or unstable soil conditions. Such measures include the installation of stone check dams and water bars to reduce storm water flow velocities and to divert overland flow to a stable and well vegetated upland location. Where needed, erosion controls shall be installed at the discharge points to water bars to avoid or minimize environmental impact.

4.1.4 Upland Access

For Work, upland access routes should be utilized to the extent practicable to avoid wetlands or other environmentally sensitive areas. If changes to access are necessary, such changes should be identified in the Pre-Construction Look-Ahead. Consult the VELCO Environmental Team if substantial changes to proposed routes (such as changing a route within an archeological area, within wetlands, near RTE species, etc.) are required. VELCO's procedure for requesting changes to Project Plans is included in Attachment A - *Policies & Procedures*.

4.1.5 Frozen or Dry Conditions

Suitable conditions may exist for equipment access and operation through wetlands without the use of Construction Mats. Prior to access under these conditions, a Dry Evaluation must be performed to determine if suitable conditions exist at the time of access. The findings of this evaluation shall be documented in an Environmental Monitoring Report. The Dry Evaluation must be performed in accordance with the "Dry Evaluation Procedure" included in Attachment A - *Policies & Procedures*.

4.1.6 Construction Mats

In many cases, access through wetlands and/or streams requires the use of Construction Mats to support machinery and to minimize environmental impacts. The use of Construction Mats is regulated by the USACE for all Work, including Maintenance activities. As such, mat deployment shall be performed in accordance with Projects Plans and within allowable limits set by the USACE. Specific information regarding the use of mats such as deployment area, authorized quantities, etc., will be illustrated on the Projects Plans. Promptly contact the VELCO Environmental Team if it is determined that additional mats are required or if the mats must be deployed in a manner that significantly differs from the plans. The need for the use of more construction mats should be determined during the Pre-Construction Look-Ahead.

4.1.7 Realignment of Construction Mats

During Construction Projects, unforeseen or unavoidable site conditions can result in the need for minor realignment of Approved Access Routes or Work Areas. Based upon site conditions at the time of Work, these realignments may bring about the need to alter the placement or the need for additional Construction Mats. The Environmental Team shall be contacted when realignments or additional Construction Mats are necessary as agency authorizations may be necessary.

4.1.8 Stream Crossings

Stream crossings are frequently required during the performance of work. If the crossing of a stream is necessary, it shall be performed in conformance with the Stream Crossing Guidance included in Attachment E1 – *Relevant BMP's*.

4.2 Work Activities

Special efforts must be made during Work to avoid or minimize impacts to Protected Resources. Work Crews should limit the area of disturbed vegetation and soil and stockpile necessary material in upland locations away from wetlands and/or streams. Other impact mitigation measures include the use of erosion controls and properly restoring disturbed areas following the completion of Work.

4.2.1 Materials

Prior to the performance of Work, materials such as insulators, poles, cross arms and braces may be placed along the ROW. Construction material should be placed outside of Protected Resources. If constraints require the placement of material within a sensitive area, consult with the Environmental Team for review and authorization. Upon delivery, all treated wooded poles shall be inspected for evidence of unusual “sweating” of wood treatments, such as pentachlorophenol. If evidence of unusual treatment is observed, than the material should be segregated for further evaluation and not installed until deemed suitable.

If poles or other material are to be staged along areas of vehicular travel, appropriate safety flagging, signage, and/or traffic cones must be deployed.

4.2.2 Erosion Controls

Erosion controls shall be installed as indicated in Project Plans, or as needed to prevent impacts to Protected Resources.

Typical erosion control devices or measures include the use of staked hay bales, silt fencing, mulch, water bars, etc.

These controls are often required in areas of high erosion hazard. For example, Work on steep slopes or in proximity to a wetland or stream would likely require the use of erosion controls. These controls are installed between the Work Area and the resource to be protected prior to the performance of earth-disturbing activities. Information regarding erosion controls are found in Attachment C- *Typical Best Management Practice Drawings* and are further detailed in the Vermont Standards and Specification for Erosion Prevention and Sediment Control available from the Vermont Agency of Natural Resources - Water Quality Division.

During frozen conditions, it may not be possible to install certain types of erosion controls. In such cases, suitable alternatives such as hay mulch or wood chips can be utilized. Whenever erosion controls are installed, they must be regularly inspected and maintained to ensure that the controls are performing effectively.

For Construction Projects, inspections of erosion controls shall be performed in accordance with permit requirements by the ECC and the OSPC. Inspection records shall be maintained until the Work Area is completely restored and adequate vegetation is established to prevent soil erosion. Inspections and associated response actions and maintenance activities shall be documented in a report format in accordance with the VT ANR *General Permit 3-9020 for Stormwater Runoff from Construction Sites* and in conformance with the VELCO Environmental Inspection and Compliance Report located in Attachment B – *Environmental Inspections and Reporting*. Copies of all inspection reports shall be submitted to the Environmental Team and maintained on site.

4.2.3 Grading Activities

As outlined in Section 4.2.2, erosion control measures shall be installed before the performance of soil disturbing activities at the Work Area. Soil disturbance and grading activities should be limited to the areas necessary to complete the Work. Required grading of access routes and equipment pads must be performed in accordance with Project Plans and permits, and should be kept to the minimum amount necessary for safe and efficient operations. Following the completion of Work, the disturbed soil should be properly stabilized and reseeded (if existing root and seed stock are absent) to promote revegetation and to mitigate the risk of soil erosion. Grading of soil or the construction of permanent equipment pads within wetlands should not be performed unless specified in the Projects Plans and associated permits.

For Construction Projects, the OSPC is responsible for amending the Project Plans to reflect additional areas of disturbed soil, such as access roads, equipment pads, etc. Additionally, changes to erosion control measures, such as deploying fixed controls in a different configuration, or utilizing different controls than those contains in the EPSCP require prior review and approval before use.

4.2.4 Soil Handling Activities

Proper handling of soils involves the segregation of topsoil from subsoil, which should be stockpiled separately from the excavated subsoil and spread as a top dressing over the Work Area to facilitate restoration. In upland Work Areas, excess soil (if any) may be spread within the limits of disturbance and seeded and mulched. For wetland areas, all excess soil must be removed from the wetland and transported to a suitable upland location (away from Protected Resources) and evenly spread and stabilized. Additionally, when working in wetlands or wetland buffers (including pole setting, guy anchor installation, grounding, etc.), any temporarily excavated soils must be stockpiled on top of Construction Mats (if permitted for use) or other suitable barrier to mitigate impacts to the wetland. If dry or frozen wetland conditions are present, excavated soil may be stockpiled on the ground surface provided the area was properly inspected for suitability by the ECC prior to the performance of the work. Restoration of the excavated wetland requires backfilling of the removed soils in reverse order to restore existing soil horizons and to maintain the root and seed stock of native wetland vegetation.

With respect to Construction Projects, soil handling shall be performed as described above and in conformance with the Project Plans and permit conditions.

4.2.5 Dewatering

Dewatering activities may be required during the performance of Work. If dewatering of excavations is necessary, it shall be performed in conformance with the Dewatering Plan included in Attachment A – *Environmental Policies and Procedures*.

Prior to dewatering activities, a project-specific dewatering plan shall be developed in accordance with the VELCO Dewatering Plan referenced above. The completed dewatering plan shall be reviewed and approved by the EPSC Specialist, the OSPC, and the Environmental Team and may be submitted to the VTANR, if required. Monitoring is required throughout the dewatering activity by the EPSC Specialist and OSPC to ensure compliance throughout the Work. Additional inspections will also be conducted by the Environmental Team.

4.2.6 Work at Structures in Wetlands

For Construction Projects, the Project Plans and permits describe the Approved Access Routes and quantities of authorized temporary fill (Construction Mats) to be used in wetlands. In some cases, a “historically filled” access road may be present, which would allow for equipment access without the use of construction mats; however, these routes must be shown as Approved Access Routes prior to use. If needed, Construction Mats may be deployed on “historically filled” roads provided the matted area does not extend beyond the “foot print” of the existing route. Consult the Environmental Team if any changes (such as the need for more mats, changing access, etc.) to Project Plans depicting mat deployment are necessary. VELCO’s procedure for requesting changes to project plans is included in Attachment A - *Policies & Procedures*. Information regarding mats and temporary bridges are found in Attachment C- *Typical Best Management Practice Drawings*.

Access and Work at structures in wetlands shall be performed with the use of Construction Mats (where authorized) or during dry or frozen conditions to mitigate impacts to the environment such as soil compaction, rutting and damage to vegetation beyond its capacity to naturally revegetate. Work in wetlands during dry or frozen conditions also includes the use of low-ground pressure equipment, such as tracked vehicles. The method of access will vary and will be dependent of project permits, the time of year and weather conditions.

4.2.7 Work at Other Sensitive Areas

In order to ensure the other sensitive areas such as archeological sites, Rare and Irreplaceable Natural Areas (RINA), and populations of Rare, Threatened and Endangered Species (RTE) located within the ROWs are protected during the performance of Work; the following precautions shall be taken:

- Work that involves earth disturbance (e.g., topsoil removal, grading, excavation, soil stockpiling) outside the area of historic disturbance (e.g. disturbed area around a structure, existing corridor access, etc) should first be assessed for potential impacts on known National Register-eligible archaeological sites, RINA and RTE. The Environmental Team will perform this assessment by reviewing VELCO’s records

pertaining to these resources. If impacts are unavoidable, a mitigation plan and/or permits will likely be needed. Any activities adjacent to these sites should include protective barriers to prevent inadvertent equipment access into the area.

In addition to the measures outlined above, VELCO in consultation with the VTANR and the ACOE develops additional Best Management Practices to protect sensitive resources. Relevant documents are included in Section E – Relevant BMPs.

4.2.8 Soil Disturbance

Work Crews shall limit disturbance to soil and vegetation of the area necessary to safely operate equipment, execute the Work, and account for soil stockpile areas. When practicable, Work Crews should attempt to conduct Work with the use of low-ground pressure or tracked equipment to avoid impacts to vegetation and soil, such as rutting or compaction. Construction Mats are typically utilized to cross wetlands or streams to access structures and to stage equipment when working on structures in wetlands and/or within archeological areas. Construction Mats must be deployed in accordance with Project Plans and removed upon completion of the work.

4.3 Field Refueling and Equipment Maintenance

Work Crews should routinely inspect equipment for evidence of leaks, fuel spills, drips, and/or seeps. Faulty equipment shall be promptly repaired to maintain the equipment in a safe and proper working condition and to reduce the chance of an accidental release of oil or hazardous material (OHM).

All vehicle refueling and vehicle maintenance should be performed at least 100' away from Protected Resources. Refueling and vehicle maintenance operations should be performed on an impervious surface (such as a paved parking lot) to minimize the potential of a release of OHM to the environment. The operator shall take all usual and reasonable precautions during refueling and maintenance activities to prevent an accidental spill. These precautions include the use of portable basins or similar secondary containment devices, use of ground covers such as polyethylene sheeting, and/or the use of containment booms and absorbent pads. Additionally, spill response kits shall be readily available on all equipment and at refueling stations. Information regarding spill kits is included in the Spill Response and Clean-up Procedure located in Attachment A – *Environmental Policies and Procedures*.

4.3.1 Releases of OHM

If a release of OHM occurs, properly trained site personnel shall implement response actions as outlined in the Spill Response and Cleanup Procedure found in Attachment A – *Environmental Policies and Procedures*.

At a minimum, the sequence to respond to a release is:

- 1) Stop the release, if it is safe to do so
- 2) Prevent the release from migrating into sensitive areas through the deployment of spill booms, absorbent materials, sand bags, etc.
- 3) Immediately notify the Field Coordinator and the Environmental Team.

Releases of OHM must be immediately reported to the Environmental Team and an Incident Report prepared in accordance with the “Incident Reporting Procedure” included in Attachment A - *Policies & Procedures*. The response to all releases of OHM (regardless of quantity spilled) and associated cleanup activities shall be performed in accordance with the Spill Response and Cleanup Procedure found in Attachment A – *Environmental Policies and Procedures*.

4.4 Restoration

After Work has been completed, all used material and refuse should be removed from the ROW for proper disposal. Old poles should be removed and backfilled to grade. In some cases, old poles may be cut at or below the ground surface with the remaining section left in place. Removed material may be temporarily stored within the ROW pending removal and disposal. Old material should not be stored within wetlands, archeological areas, or other environmentally sensitive areas.

The following sections describe restoration activities that should be performed after Work has been completed. For Construction Projects, Work Crews should refer to the Projects Plans and permits for specific restoration requirements.

4.4.1 Disturbed Areas

Temporarily disturbed areas (except equipment pads and access routes) shall be returned to their original grade and stabilized with mulch and seeded with the appropriate seed mix (if sufficient root and seed stock are absent). If necessary, temporary equipment pads and access roads may be rough graded (removal of stumps, boulders, steep slopes, etc.), to prepare an adequate seed bed for successful revegetation. These areas should then be stabilized with mulch or other appropriate soil stabilization measures.

4.4.2 Improved Areas

Existing improved areas such as agricultural fields and lawns should be restored to a condition to that which existed prior to the start of the Work unless otherwise dictated by easement language. All damage to property as a result of the Work should be documented (with appropriate photo-documentation) and promptly repaired or replaced.

4.4.3 Construction Mats/Temporary Bridges

Following the completion of Work, Construction Mats and temporary bridges shall be removed and the area restored to pre-Work conditions.

Special precautions shall be taken to promptly stabilize areas of disturbed soil located near wetlands and streams. “Matted” areas within wetlands will be allowed to naturally revegetate from existing root and seeds of native plant species. If conditions warrant, wetland seed mix may be broadcasted over the “matted” area to supplement the existing seed and root stock. The use of mulch in wetlands shall consist of certified “weed-free” hay mulch or straw mulch to mitigate the risk of the spread of invasive plant species.

4.4.4 Erosion Controls

After Work has been completed and the area has successfully revegetated, and upon field inspections and approval of the Environmental Team, silt fences, staked hay bales, and any other fixed erosion control measures shall be removed for proper disposal. Hay or straw bales utilized for erosion controls may be used as mulch for disturbed areas. Silt fence, stakes, and baler twine shall be removed from the Work Area.

4.4.5 Work Sites and Material Storage & Staging Areas

Upon completion of Work, Work Crews shall remove all work-related trailers, temporary buildings, refuse, waste soil, and any unused material. All areas shall be restored to a stable condition to ensure that the work site is left in an environmentally sound condition.

4.5 Summary of Key Construction Best Management Practices

All Work Crews must attend required environmental and safety training. Work crews shall execute Work in accordance with Project Plans and permits, if applicable, and the best management practices set forth in this manual. Work Crews are encouraged to consult with the Environmental Team if any questions or concerns arise.

5.0 TYPICAL BEST MANAGEMENT PRACTICE DRAWINGS

Typical BMP drawings of several commonly used methods for achieving ROW access, wetland and stream crossings, and erosion control measures are included in Attachment C

– *Typical Best Management Practice Drawings for ROW Access, Maintenance and Construction.* These typical BMP drawings are provided as a general reference for use by Work Crews. **Permit-specific or contract-specific specifications shall prevail over the provided guidance drawings.**

ATTACHMENT A

Environmental Policies & Procedures

- A-1 Incident Reporting Procedure**
- A-1.1 Hazardous Material Release Response and Clean-Up Procedures**
- A-2 Dry Evaluation Procedure**
- A-3 Pre-Construction “Look Ahead” Procedure**
- A-4 Plan Amendment Procedure**
- A-5 Dewatering Plan**
- A-6 Corridor Access Review Procedure**
- A-7 Unanticipated Discovery Response Procedure**

A-1 Incident Reporting Procedure

Summary:

VELCO's Incident Reporting procedure is designed to facilitate the prompt identification and associated reporting and responding to environmental field incidents of possible non-compliance. Some examples of permit or environmental non-compliance include:

- i. placing fill (including construction mats) in wetlands not authorized by permit
- ii. unauthorized disturbance (including ruts) in wetlands
- iii. spills of hazardous materials (e.g., diesel fuel, oil)
- iv. failure to adhere to EPSC plan provisions (e.g., failure to maintain silt fences, turbid runoff leaving work area)
- v. unauthorized activities in archaeologically sensitive areas

It is important to recognize that personnel are encouraged to report all incidents of possible environmental non-compliance. A determination as to whether an incident is an actual violation will be made by the VELCO Environmental Team and Legal Counsel, if necessary. An Environmental Incident Report should be used to document the incidents.

Procedure:

1. Field personnel will secure the incident location and no further activity shall occur until a field investigation is conducted and instruction to proceed is received from the Environmental Team.
2. The incident shall be immediately reported to the Field Coordinators and the Project's Environmental Consultant.
3. Field Coordinators and/or the Environmental Consultant will immediately notify the Environmental Team and the Construction Manager of any incident.
4. Upon notification, the Environmental Team will review the incident and will notify VELCO Legal, who will provide 48-hour PSB notification, as necessary.
5. An on-site field investigation/information gathering exercise will be conducted cooperatively between the Environmental Consultant and a Field Coordinator within two (2) hours of the incident reporting. An incident report will be completed and submitted on the day the incident occurs.
6. Within 24 hours of the incident, the VELCO Environmental Team will convene an Incident Investigation Panel. The purpose of the panel is to:
 - a. Investigate the incident. Conduct field visits and interviews as necessary to ascertain the facts;
 - b. Determine the cause of the incident; and
 - c. Provide recommendations regarding corrective actions to prevent similar incidents from reoccurring.

7. By the end of next business day following the day of the incident, the VELCO Environmental Team will brief Management on the cause, recommendations, and proposed corrective actions.
8. Within 72 hours, the VELCO Environmental Team will implement corrective measures. These measures will be discussed at the project construction meetings and documented in the meeting logs.
9. All field crews will be briefed during project meeting of new procedures/requirements/lessons-learned.

A-1.1 Hazardous Material Release Response and Clean-Up Procedure

Table of Contents

| | |
|---|---|
| I. General | 1 |
| II. Spill Prevention | 1 |
| A. SPCC Plan..... | 1 |
| B. Oil and Hazardous Material Storage..... | 1 |
| C. Equipment Checklist..... | 2 |
| D. Tailboard..... | 2 |
| E. Spill Kits | 2 |
| F. Refueling..... | 3 |
| 1. Bulk Delivery Procedures..... | 3 |
| G. Maintenance of Equipment on the ROW..... | 4 |
| III. Spill Response..... | 4 |
| A. Spill Response Actions | 4 |
| B. Notifications..... | 4 |
| IV. Clean-Up/Remediation | 5 |
| A. General Clean-Up Requirements | 5 |
| B. Sampling | 5 |
| C. Clean-Up Guidelines..... | 6 |
| D. Clean-Up of Petroleum Contaminated Soil | 6 |
| E. Transportation and Disposal of the Contaminated Material | 6 |
| F. Reporting..... | 7 |

VELCO

Hazardous Material Release Response and Clean-Up Procedure

I. General

The contractor is solely responsible for all liabilities (e.g. spill response, reporting, clean-up/remediation, and all associated costs, fines or fees) associated with any and all releases of oil and hazardous materials resulting from their employees or subcontractors and/or equipment. The contractor's handling, storage, utilization, and clean-up of any and all oil and hazardous material (OHM) must comply with all Federal and State statutes, rules and regulations, as well as with VELCO's procedures.

II. Spill Prevention

Equipment that contains oil or hazardous materials shall be stored and maintained so that spills and leaks are prevented. Minimum spill prevention actions shall include:

- Daily inspections of the storage of oil and hazardous material-containing equipment including 55-gallon drums, fuel tanks, and oil-containing equipment (e.g. equipment with hydraulic hoses, etc)
- Equipment containing oil shall not be stored or left over night in resource areas (e.g. wetlands)
- No refueling shall occur in resource areas

Equipment and storage containers holding oil or hazardous materials that are leaky or inadequate shall not be kept at the project site.

A. SPCC Plan

If the maximum total above ground storage capacity for oil of any kind, at the total work area, exceeds 1,320 gallons, a Spill Prevention, Control, and Countermeasure Plan (SPCC) Plan must be prepared and implemented as required by the federal SPCC Rule.

VELCO may require the contractor to provide a Spill Prevention Plan at any time during the performance of a project, regardless of the oil storage capacity at the total work area. This Spill Prevention Plan will be provided within three (3) weeks of the request and shall be subject to review by VELCO Environmental and/or the Project's Environmental Inspectors.

B. Oil and Hazardous Material Storage

Regardless of whether an SPCC Plan is required, the following general procedures shall be followed:

1. An effort will be made to store only enough products required to perform the work.
2. All materials stored onsite will be stored in a neat, orderly manner and, if possible, under a roof or in a containment area. At a minimum, all containers will be stored with their lids on when not in use.

3. Drip pans shall be provided under all dispensers.
4. All petroleum storage containers will be clearly labeled, closed when not in use, and placed on secondary containment pallets/basins under a roofed storage area or protected by berms/bunkers on an impervious surface. Temporary or mobile storage tanks shall be kept on secondary containment pallets/basins under a roofed storage area or protected by berms/bunkers on an impervious surface, to the extent possible.
5. Equipment and storage containers holding oil or hazardous materials that are leaky or inadequate shall not be kept at the project site.
6. Products will be kept in their original containers with the original manufacturer's label in a legible condition.
7. Substances will not be mixed with one another unless recommended by the manufacturer.
8. Whenever possible, all of a product will be used before disposing of the container.
9. Manufacturer's recommendations for proper use and disposal will be followed for the disposal of the container and all surplus product.
10. Material Safety Data Sheets (MSDS) for each product with hazardous properties that is used at the Project will be obtained and used for the proper management of potential wastes that may result from these products. The MSDS will be made available to all project participants.

C. Equipment Checklist

Contractors shall perform equipment checks and document each inspection (see general template checklists, pages 1 to 3 of the Attachment). Inspections of equipment containing oil and/or hazardous materials shall be performed and documentation/checklists shall be maintained onsite for review upon request of VELCO.

D. Tailboard

Equipment checklists and inspections, spill kits and storage and refueling of equipment around sensitive environmental/ resource areas should be addressed at part of the safety tailboard briefing.

E. Spill Kits

Spill Kits provide an active countermeasure that can be deployed rapidly following the discovery of spills of oil or hazardous materials. Spill kits shall be kept in proximity to the work sites.

Spill kits shall be provided where oil or hazardous materials are stored, and shall be accessible at all times by trained personnel. VELCO reserves the right to require the contractor to strategically place spill kits at other work locations that contain adequate spill response supplies, which typically includes the following:

1. Personal Safety Wear:
 - Tyvek® Suit
 - Aprons
 - Shoe Booties
 - Chemical Goggles

- Solvent Resistant Gloves
- 2. Absorbents:
 - Granular sorbent
 - Sorbent booms
 - Sorbent static resistant pads
- 3. Clean Up Equipment:
 - Repair Putty
 - 55 Gallon Steel Drum and hazardous waste label
 - Drum Liner
 - Solvent Resistant Broom
 - Non-Spark and Solvent Resistant Shovel
 - Residue Bags (50 each)

Additionally, the contractor shall maintain smaller spill kits with each piece of mobile oil-containing equipment. Smaller spill kits typically include the following:

- Absorbent Socks
- Sorbent Mat Pads
- Repair Putty
- Safety Goggles
- Label
- Protective Gloves
- Tyvek® Suit
- Residue Bag

F. Refueling

All refueling of vehicles, fuel storage tanks, and equipment; or any other transfer of fuel, oil, or hazardous materials shall be performed away from waters of the State. At a minimum, refueling and transfers shall also be performed at least 50 feet away from any resource area. The following procedures shall apply to all refueling and transfer operations:

1. Bulk Delivery Procedures:

- No bulk deliveries shall take place without contractor supervision and approval.
- Check all gauges and volumes prior to fuel transfer
- The delivery truck wheels shall be chocked as soon as the truck is parked in the fuel transfer position.
- Before fueling, flexible transfer hoses shall be inspected for cuts, abrasion, and damaged ends.
- All fuel transfers shall be monitored.
- Tanks shall not be filled to overflow capacity.
- Final inspection of the tank truck and tank feed lines shall be conducted to assure that all valves and ports are closed and that no leaks have occurred.

G. Maintenance of equipment on the ROW

At VELCO's request, the contractor shall provide VELCO with written procedures for review, that will be followed for maintenance of the contractor's equipment while it is on any property subject to VT Transco's/VELCO's control (e.g. ROWs, substations, etc). The maintenance procedures shall address routine fluid changes, hydraulic hose replacements, containment while performing maintenance, etc.

VELCO reserves the right to require the contractor to remove specific equipment from the project, if such equipment has had an unacceptable number of releases or poses an unacceptable risk of a release of OHM. Upon notification by VELCO, the contractor shall have two (2) business days to remove the equipment from the site.

III. Spill Response

A. Spill Response Actions

The contractor shall be responsible for all spill response, clean up, environmental quality sampling and disposal. The contractor must be properly trained to perform these work activities. VELCO may require the contractor to subcontract the services of a spill response contractor for any size spill, at its discretion.

Spill Response Actions include the following:

1. Assess the health and safety hazards associated with the spill
2. Perform initial response activities, if trained to do so
3. Contact appropriate VELCO personnel
4. Contain and clean up the spill

B. Notifications

All hazardous material releases shall be immediately reported to the VELCO Environmental Compliance Inspector immediately after the spill has been contained.

The following information shall be relayed to VELCO as soon as possible:

- Location of spill
- Source of spill (equipment, AST, vehicle, etc.)
- Time spill occurred and/or was discovered
- Estimates of quantity and type of oil/hazardous material spilled
- If the spilled material has entered or is near any watercourse (storm drain, stream, wetland, etc.)
- Description of any containment and/or clean-up activities
- Any other pertinent information (access to spill site, current weather conditions)
- Any injuries or threat of injuries
- Additional response actions needed and schedule of clean-up

VELCO staff shall perform the initial notifications to the Vermont Agency of Natural Resources (VT ANR), which required immediate notification by telephone of spills, and

a written report within ten (10) days following any discharge or release. VELCO shall make this initial notification on behalf of the contractor.

Depending on the nature of the spill or discharge to the environment, it may be necessary to contact additional regulatory agencies. The agency to be contacted will depend on the nature and amount of the spilled material and the location of the spill.

IV. Clean-Up/ Remediation

VELCO recommends that contractors utilize a professional spill response contractor to respond to spills over 2 gallons.

A. General Clean-Up Requirements

All clean-up of spills shall be conducted in accordance with the Vermont Hazardous Waste Management Regulations¹, the Vermont Agency of Natural Resources' Guidelines for Petroleum Contaminated Soil and Debris², and any site-specific approvals from officials at the Vermont ANR, Waste Management Division. All personnel performing clean-up activities must be properly trained.

Contaminated soil and media should be cleaned up as soon as possible after the initial spill response has been completed, the source of the spill stopped, and the spill contained.

The contractor shall take appropriate steps to containerize all contaminated soil and media, or to encapsulate petroleum contaminated soil and debris on-site within plastic sheeting, as appropriate for the specific situation. Unless otherwise directed by VELCO or the regulatory agency, the contractor shall ensure that all contaminated soil shall be excavated from the ground at a spill site, and confirmatory samples are collected.

B. Sampling

All contractors (or a professional spill response contractor or qualified environmental consultant subcontracted by the contractor) shall have a calibrated Photo Ionization Detector (PID) onsite to assist clean-up activities and to confirm removal of petroleum contamination. The PID shall be a minimum 10.6 electron volt (eV) unit and shall be properly calibrated. The PID shall be operated by trained staff in accordance with the Agency Guidelines for Petroleum Contaminated Soil and Debris⁴.

At a minimum, sampling of the impacted soil/environmental media following a spill will be conducted with the PID in the field. On a case-by-case basis, VELCO and/or the VT ANR may request laboratory testing of soil and/or water samples and will determine appropriate sampling and laboratory analytical methods. Sampling shall be conducted by a qualified individual. Confirmatory samples shall be taken from the excavation to confirm that contamination does not remain in the ground at levels exceeding applicable

¹ Vermont Hazardous Waste Management Regulations, Effective: October 15, 2006

² Agency Guidelines for Petroleum Contaminated Soil and Debris. Vermont Agency of Natural Resources, Waste Management Division, Effective: August 1996

state or federal levels. When contaminated soil is to be transported off-site, additional laboratory testing is typically required.

C. Clean-Up Guidelines

Clean-up of contaminated material shall meet all applicable Federal and State regulations. Petroleum contaminated soil and debris shall be managed in accordance with ANR Guidelines⁴, and with case-by-case approval by VELCO and the ANR Waste Management Division. Soil and debris contaminated with hazardous materials other than petroleum shall be managed in accordance with the Vermont Hazardous Waste Management Regulations³. When required by these Regulations, corrective action and follow-up site investigations shall be conducted by a qualified environmental consultant in accordance with ANR guidelines³.

D. Clean-Up of Petroleum Contaminated Soil

For petroleum-contaminated soil, the soil may be stockpiled temporarily on-site, on plastic sheeting subject to the following conditions:

1. 8-mil minimum thickness plastic sheeting above and below the soil
2. Sheeting securely anchored to soil pile to prevent wind damage and leaching
3. No sensitive environments (water wells, wetlands, streams, lakes and ponds, etc) are adjacent to the site, and adequate space is present to manage the soil properly
4. Management of the contaminated soil must meet the requirements of the Vermont Agency of Natural Resources' Guidelines for Petroleum Contaminated Soil and Debris.

E. Transportation and Disposal of the Contaminated Material

The contractor shall ensure proper disposal of all contaminated material, including all contaminated PPE, at a disposal facility that is approved by the Vermont ANR and that meets the requirements of the Vermont Solid Waste Management Rules⁴ and the Vermont Hazardous Waste Management Regulations³.

With prior approval from VELCO and the ANR, petroleum contaminated soil may be treated on-site in stockpiles, encapsulated in plastic sheeting, rather than requiring transport off-site as hazardous waste. Hazardous waste shall only be removed from the site by a hazardous waste transporter permitted in accordance with state and federal regulations.

³ Site Investigation Procedure, Vermont Agency of Natural Resources, Waste Management Division, Effective: June 2005

⁴ Vermont Agency of Natural Resources, Waste Management Division, Rule Number: 05PO043. Effective Date: June 12, 2006

F. Reporting

The contractor shall provide an Incident Report (see report template in Attachment XX) to the VELCO Environmental Team via electronic mail, for all spills within 24 hours of the release (the VELCO Environmental Team will then contact applicable state and federal regulatory agencies).

The contractor is responsible for producing an additional Spill Response Summary Report for all State reportable spills once all clean-up efforts have been completed and all Federal, State, and VELCO requirements have been met. The Spill Response Summary Report shall be submitted to VELCO within 30 days following the completion of clean-up and sampling work. The Spill Response Summary Report shall meet the requirements for a Site Investigation Report, from the ANR Guidance⁵, and shall include the following information:

- All information from the Incident Report
- Sampling results
- Documentation of communication with VELCO about the spill, including approvals for clean-up, transportation and disposal of contaminated material
- Manifests
- Maps depicting spill site and indicating surrounding environment and sensitive receptors (i.e. wells, wellhead protection areas, springs, basements, wetlands, streams, lakes and ponds, etc.), accompanied by a written description
- Description of clean-up and remediation activities performed, final destination of contaminated media.

A-2 Dry Evaluation Procedure

The purpose of this procedure is to identify work area within wetlands, which may become dry enough to work in without utilizing temporary fill (construction mats) and without adversely affecting the wetland. The following dry-evaluation activities must be performed for each wetland for which work is intended to be performed without the use of construction mats:

Access and work in wetlands will be performed:

- with the use of low-ground pressure or track vehicles
- when site conditions are suitable to minimize inadvertent adverse effects on wetlands, such as soil rutting deeper than approximately 6 inches, and the destruction of vegetation root systems beyond the capacity of natural re-vegetation

Suitable soil conditions would include:

- frozen ground,
- low flow or low ground water conditions,
- unsaturated surface soil conditions, or
- where wetland soils consist of silt loam or soil textures and composition sufficient to resist excessive rutting, the mixing of surface and subsurface soil layers, the movement or re-deposition of soils in the affected area, or the need to restore the contours or hydrologic condition of the wetland

With these conditions present, the determination of the suitability of the wetland soil conditions for access and construction will be determined by the collaboration of:

- a VELCO construction coordinator,
- a construction contractor Supervisor, and
- an Environmental Consultant with a sufficient background in wetland science and erosion and sedimentation control practices.

After construction is complete, wetland soils will be allowed to naturally regenerate vegetation from existing root and seed stock. In areas where wetland grades (such as hill slope seeps) pose an erosion hazard, annual rye seed may be cast over disturbed soils for temporary soil stabilization until natural vegetation sprouts, unless special permit conditions stipulate otherwise.

A-3 Pre-construction “look ahead” Procedure

The purpose of this procedure is to: 1) define the process for providing project contractors (Contractors), with environmental clearance to access and work in “Work Areas”; 2) establish the protocol for communicating clearance decisions; and 3) define roles and responsibilities associated with this process.

Work Areas are defined to include all areas where poles/structures are to be set (i.e., the box), access roads, whether permanent or temporary (including on and off corridor), staging areas, lay-down areas, and all other areas where work crews may store, stage, park and/or operate equipment or vehicles for the purpose of executing the work.

The Process

The process for establishing clearance for Work Areas will be as follows:

- Survey Crews will flag/mark Work Areas as required by applicable permits and guidelines.
- VELCO and/or its Environmental Consultant(s) will pre-inspect all Work Areas with both the Contractor and a Construction Coordinator to review and discuss applicable permits and guidelines to evaluate the planned work and associated compliance procedures.
- Findings will be documented on the projects Work Schedule Table.
- The Environmental Team will review and consult with its Environmental Consultants regarding findings and recommendations. If the Environmental Team is satisfied that work can proceed in a Work Area with minimal risk of a permit violation, the Environmental Team will indicate that the area is cleared, and work can commence and/or continue in that area.

Communication Protocol

The Work Schedule Table will serve as the primary tool for communicating that Work Areas have been reviewed and specific permit conditions, restrictions, special work practices, etc., are identified. Any decisions to deviate from the status as shown on the Work Schedule Table (e.g., cleared, hold) can be provided orally by the Environmental Team, with written follow up confirmation via email to all concerned parties within 72 hours.

Roles and Responsibilities

- The ultimate decision (from an environmental/permitting and compliance perspective) to proceed with construction (e.g., set poles/structures, pull conductors, misc. earthwork, and travel on designated access routes) will be made by the Environmental Team.
- The Environmental Consultant will serve in a consulting/guidance role and will report to the Environmental Team. Environmental Consultant personnel will also monitor ongoing

construction activity and provide guidance to the Contractor on erosion and sedimentation control and other measures to ensure project compliance.

- The Contractors are expected to complete work in accordance with permit requirements and established guidelines that have been approved by ANR and ACOE. Environmental Consultant personnel will provide guidance and recommendations to Field Coordinators, the Contractors and ECCs or Construction Supervisors, and the Environmental Team for the purpose of assisting the Contractors with this requirement.
- Contractors will ensure that all field crews have current cut sheets and project plans.
- The Contractors remain responsible for permit compliance. In addition, Contractors are responsible for ensuring that all field crews are familiar with the permit guidelines. When working in ACOE/ANR jurisdictional areas, the Contractors must be familiar with permit and plan requirements that specify approved quantities of temporary impact areas (construction mats), archeological restrictions, and mitigating construction practices such as deploying erosion controls and proper soil handling. Additionally, the contractors are responsible for wetland restoration and stabilization activities.
- The Contractors shall be required to check the Work Schedule Table on a routine basis to ensure that an area has been reviewed prior to commencing work in that area. Additionally, the Contractors shall recognize that field conditions can change on a daily or even hourly basis. As a result, the Environmental Team may “unclear” Work Areas based on changing field conditions (e.g., weather). Before “unclearing” a Work Area, the Environmental Team will consult with the Environmental Consultants, the Construction Manager, Field Coordinators and the Contractors to ensure all available steps/options are explored before ‘unclearing” the Work Area, and that the all appropriate personnel receive and understand the unclear action.
- If work has commenced in a Work Area and field conditions are identified that may result in a possible permit violation if work is allowed to proceed, the Field Coordinator, the Contractors and/or Environmental Consultants will immediately contact the Environmental Team for a determination as to how to proceed. Based on guidance from Field Coordinators and the Environmental Consultants, the Environmental Team will take one of the following actions:
 - Identify alternate methods or procedures to allow work to continue such that work can be done consistent with established guidelines and in compliance with applicable permits.
 - Stop work that has already commenced. A work stoppage may involve the temporary cessation of work activities, or the removal of equipment from the Work Area.
 - It is incumbent on the Contractor to stop work if he/she identifies field conditions that may result in a possible permit violation, regardless if the work area has been “cleared” on the Work Schedule Table.

- All parties are responsible for immediately reporting issues of concern, including possible permit deviations, to the Environmental Team.
- The Environmental Team is responsible for reporting permit deviations, including potential or known compliance violations, to Counsel.

A-4 Plan Amendment Procedure

The purpose of this procedure is to establish a process to properly document any necessary modifications to project plans, including access routes and work areas, to identify guidelines for maintaining old and new copies of project plans, and to define roles and responsibilities associated with tracking proposed changes and maintaining up-to-date plans.

- If it is determined that changes (*such as a change to access, moving a structure, or the need for more construction mats*) to the ACOE Cut Sheets or Project Plans are necessary, the respective ECC and/or a Field Coordinator (“Submitter”) shall sketch the proposed change on the Cut Sheet or Project Plan, date and initial the change and submit the drawing (via e-mail or fax 770-6446) to the VELCO Environmental Team. The Submitter shall also complete a Project Change Review Form and submit along with the sketch.
- The Environmental Team will review the proposed change and either issue approval or will engage the required resources (e.g., archeological clearance, regulatory authorization, etc.) to obtain approval. The Submitter should be aware that it may take four or more weeks to gain approval for changes that require regulatory approval (e.g., installation of additional matting, new access requiring archaeological clearance). If regulatory approval is required prior to approving the change, the Environmental Team will inform the Submitter and provide an anticipated turn-around-time from the regulators.
- Once the change has been approved, the Environmental Team will issue a response to the Submitter so indicating. The Environmental Team will also issue the amended plans to applicable project staff. The ECC, Environmental Consultants, and Field Coordinators are responsible for ensuring that their respective compliance manuals are updated with the amended cut sheet(s), field crews are utilizing the most current sheet(s), and obsolete cut sheets are removed from use.
- The Environmental Team will discuss the change with the ECC, Field Coordinators and Environmental Consultants to make sure they understand the change. It is incumbent on the ECC and Field Coordinators to review and discuss the changes with the construction crews prior to performing the work.
- As part of this process, the Environmental Team will electronically update the project files to reflect the changes. When a critical change is made (e.g., off-corridor access, realigned access through archaeological sensitive areas or wetland), a revised page to the Project Plans will also be issued along with the corresponding cut sheet. The new plans will be issued with directions identifying proper plan handling and updating procedures. Specifically, the outdated sheet(s) will be marked by the plan holder as “obsolete” and the new sheet(s) will be inserted in the rear of the plan binder in “Attachment A – Revised Plans”. Attachment A will contain all plan changes. The amended plan will also be submitted to the appropriate regulatory agencies, as applicable.

A-5 Dewatering Plan

Introduction:

The following document is intended to provide guidance to engineers, maintenance, and construction crews for dewatering activities, with respect to environmental resources, during planning and implementation of dewatering activities for any VELCO Project. This plan is intended to be used as a general guide of BMP's for dewatering activities and should be used in collaboration with the project plans, agency permits and site-specific characteristics. Necessity of dewatering efforts will be evaluated based on site conditions, and shall be in accordance with the project plans and with the approval of the On-site Plan Coordinator (OSPC), Erosion Prevention and Sediment Control Specialist (EPSC Specialist), and BELCO's Environmental Team.

Environmental Issues:

Dewatering of construction activities might be necessary at VT TRANSCO project sites. Dewatering structures should be located outside of environmental resource area (e.g., wetlands, streams, arch sites, RTE locations, and any associated buffers) to the fullest extent possible. Dewatering basins must be properly constructed and monitored. Refer to the project's construction detail sheets for specifications at locations where dewatering basins cannot be practically located outside of protected resources (e.g., large wetlands). A dirt bag/filter bag dewatering setup will be utilized. Alternatively, a dewatering discharge structure can be deployed on top of a construction mat. Any dewatering structure situated within a wetland will be continually monitored to ensure no turbid discharge. Wetlands (Class II and Class III) with standing water are considered Waters of the State and are subject to the same discharge restrictions as streams and direct conveyances to other Waters of the State.

Varying types and sizes of dewatering basins can be constructed. The type and size of each dewatering structure will be determined by the OSPC, ESPC Specialist, the construction supervisor, and with consultation provided by VT TRANSCO'S Environmental Team. Site characteristics that will be assessed when determining location type and size of dewatering basin include topography, soil types, depth of water table, and proximity to environmental and cultural resources.

Dewatering structures will *not* be constructed in steams, archeology sites, or proximate to RTE species. It is highly important to monitor dewatering activities regularly to ensure the system is functioning properly. Proper maintenance of dewatering basins includes the removal of excess sediments, regular inspections to assess structural integrity, and visual verification that no discharge of turbid water is occurring. It is a *deviation of the project's permits* to discharge visually turbid water to Waters of the State.

If drawn-down related activities are to be used to lower the water table prior to construction, these areas must not be located in any of the above mentioned resource areas. In addition, wetlands designated as Class II by the State of Vermont have a 50 foot buffer associated with them. This buffer zone is regulated by the State, therefore draw-down activities must *not* occur within the associated wetland buffers unless authorized by permit. State of Vermont designated

Class III wetlands do not have an associated buffer and therefore do not have buffer restrictions. However, due to the sensitive nature of these resources, the VT TRANSCO Environmental Team will be consulted prior to any dewatering or draw-down activities located proximate to any wetland or stream.

Water discharged from dewatering effort may contain suspended sediments. These sediments will be transported through dewatering equipment and deposited upon release. It should be recognized that these dewatering activities could potentially create large amounts of sediment deposition upon discharge. Therefore, it will be necessary to evaluate each discharge location to determine if a dewatering basin is required or if we can dewater to a splash pad in upland areas. Factors that should be considered when discharging to uplands include: proximity to resource areas, vegetative cover, landowner concerns, erosion potential, and site topography.

In order to maintain reporting compliance for VT TRANSCO project's Stormwater Discharge permit, each location where dewatering activities are required, a plan book amendment record will be kept onsite. This record keeping protocol will include a CPG 3-9020 Minor Amendment Record form, which will clearly describe each dewatering activity's location, the EPSC practices employed at each location the location of each discharge, the duration of the dewatering activity, and the name of the approving party (the approving party for these efforts will be the EPSC Specialist, who has been approved by the DEC), as well as, a sketch on the site plans illustrating the location of the excavation that will be dewatered, the location of the dewatering device, the type of dewatering device utilized, and the location of the discharge. In addition, the Individual Stormwater Discharge permit states, "Prior to any dewatering activities which may result in the pumpage reaching State waters by surface flow, the Principal Permittee shall measure and document the turbidity value to ensure that it is sufficient to comply with the Vermont Water Quality Standards". For more information on the dewatering activities please refer to the Individual Stormwater Discharge Permit, Part II Erosion Prevention and Sediment Control Requirements, section H Dewatering Activities, Disturbance Limits.

Construction Considerations:

Soil boring data has been collected at several sites that may require dewatering (data available upon request). The data collected from these sites specifically include moisture characteristics of soil and soil classification. This data will be important in assessing the saturation of soils and erosion potential. Evaluating the type of soils present and the amount of water that each site has the potential to realize, will assist in the determination of what type, size and number of dewatering structures that will be required.

Potential output of dewatering activities should be considered when designing the dewatering system. The system's capability to effectively contain the flow that will be realized from pumping efforts, as well as, the system's ability to filter sediment loads will be evaluated when determining size and location of installation. The design of these dewatering basins should be capable of handling all the sediment that will be discharged from the dewatering areas, such that no sedimentation leaves the dewatering structures. Multiple structures may be necessary to adequately accept and process large flow volumes.

A-6 Corridor Access Review Procedure

The purpose of this procedure is to establish a streamline approach to identifying and selecting suitable access routes for the construction and continued operation of transmission lines, substation facilities, and related infrastructure. Prior to conducting work each project area shall be reviewed for suitable access routes. This review may require a collaborative effort involving several VELCO departments (e.g., Environmental, Vegetative Management, Right-of-Way, and Line Crew), VELCO consultants, and the respective landowners. The inclusion of the appropriate stakeholders will expedite access selection, ensure proper review, and allow for faster turnarounds for use by work crews. VELCO strives to select work access routes that avoid or minimize impacts to private existing routes that allow equipment safe and efficient access to the corridor via public roadways/lands. VELCO has designed the following procedure with respect to off-corridor access route selection:

Procedure:

1. To the extent practicable, the corridor should be accessed via public roads.
2. When public road access is not possible, access should be gained via existing paths, driveways or other established, previously disturbed/developed routes.
3. Examples of viable access routes include:
 - Farm roads;
 - Log landing areas or logging roads;
 - Recreational paths (e.g., ATV trails, VAST);
 - Existing or former railroad beds ; and
 - Private driveways or roads
4. If existing routes are not available or suitable for use, permanent or temporary access routes may be created through previously undisturbed areas, with the appropriate permissions.

Planning and Approvals

- As part of the planning process, off-corridor access routes will be mapped in a manner consistent with VELCO mapping standards. The map(s) should clearly identify the entire proposed access route, from its point of origin at a public access point to the interception point on the corridor.
- All off-corridor access routes, with the exception of improved roadways or paths (e.g., pavement, gravel, compacted dirt) shall include an appropriate level of review by VELCO's qualified archaeology consultant(s). Access routes through known archeological areas may require further archaeological investigation or route adjustment to avoid.
- All off-corridor access routes, with the exception of improved roadways or paths(e.g., pavement, gravel, compacted dirt) shall include an appropriate level of review by a

qualified environmental professional to evaluate potential influence on environmentally sensitive areas (e.g., wetlands, stream crossings, and Rare, Threatened, or Endangered Species). When potential impacts are anticipated, VELCO will work to identify alternative access routes or develop impact mitigation measures consistent with applicable regulatory requirements.

- Specifically, the method of performing work in wetlands shall be conducted pursuant to applicable state BMP’s and VELCO’s approved access hierarchy which is as follows:
 - i. Minimize disturbance by using existing travel lanes.
 - ii. Work in wetlands during dry or frozen conditions.
 - iii. Use temporary swamp mats in wetland areas where ruts and significant soil disturbance is anticipated.
 - iv. Construct temporary access roads using rushed stone on filter fabric or brush matting.
 - v. Construct permanent road.

- Prior to commencement of work, regulatory requirements shall be accounted for in applicable permits and plans. The table below is to serve as a quick reference guideline, identifying the possible regulatory and permitting obligations.

| <i>Impact*</i> | <i>Required Permit/Approval</i> |
|---|---|
| Wetlands | ACOE 404 Permit, VT ANR Wetlands Permit |
| Earth Disturbance (not in wetlands or wetland buffer, if present) | Construction Permit |
| RTE | Takings Permits – Special Work Plans |
| Sensitive or Known Archaeological Sites | DHP Concurrence |

* Table provided as a general guideline only. Construction crews shall consult the VELCO Environmental Team for project-specific permit approvals.

Access Use and Control

Access control will vary depending on the work location, the type of work, landowner restrictions, and applicable permit/plan requirements. Some examples of the controls or measures that may be employed to control and manage access include the following:

- Signage at the access origin point to guide workers;
- Flagging/marking to ensure that vehicles and equipment travel long the approved route; and
- Fencing/gates – In most cases, VELCO does not have the legal right to install impediments to control access on public or private property. However, in certain situations, a gate can discourage access by ATVs and other unauthorized users. In these situations, VELCO shall contact the property owner for approval and coordinate arrangements to install fencing/gates. If necessary, temporary construction fencing may be installed to control unauthorized use of a ROW access route.

Care and Maintenance of Access Routes

Like all travel ways, proper care and maintenance is required to ensure that the access route provides for safe and reliable use. To accomplish this, while also avoiding or minimizing impacts to sensitive areas, the following practices should be followed:

- In accordance with state wetland BMP's, matting shall be used to minimize impacts to wetlands. Matting has been used in upland and wetland buffer areas without permit approvals to protect existing vegetation, mitigate soil disturbance (e.g., rutting), and improve travel efficiency and safety.
- Disturbed soil and unstable access route surfaces shall be maintained in accordance with the impact mitigation measures contained in this document and within the Vermont Standards and Specification for Erosion Control & Sediment Control – 2006.
- At the point where an access route meets a paved public road, a mud trap or construction entrance is often required to mitigate soil transport from vehicles and/or equipment onto the public road. Matting can also be used for this application. Mud traps are to be installed in accordance with this manual and in consultation with the VELCO Environmental Team, as coordination with local town and highway department officials may be required.
- Culverts, temporary bridges and other drainage control/water diversion measures may be required during the construction, use and care of access routes. These measures shall be constructed in accordance with applicable state and federal regulations, and this manual. When such measures are deemed necessary but not specified in project permits and plans, the VELCO Environmental Team will be consulted and BMP's will be implemented.

Changes to Access Routes or Controls

It is critical that all travel be on access routes (both on and of corridor) that are identified and appropriately documented. If it is necessary to change or alter the access for any reason, the VELCO Environmental Team **must** be consulted (refer to the Section A-4 *Plan Amendment Procedure*). The entity requiring the plan amendment will work with necessary VELCO departments to appropriately assess state and federal regulatory implications, and requirements to implement this change, which may include: 1) obtain the necessary permits/approvals to use the existing access, 2) evaluate for an alternative access route (if present) that avoids or minimizes impacts to identified sensitive areas; and/or 3) obtain the necessary permits/approvals to use the alternative access.

Other changes that require VELCO Environmental Team approval prior to work include:

- Change in route;
- Expansion in route or staging/work areas;
- Additional matting in wetland areas exceeding or in different configuration than specified on project plans (e.g., cut sheets); and
- Installation or replacement of any culverts or temporary bridges not shown on the project plans or specified in the permit.

Restoration

After work completion, VELCO and its contractors assume responsibility for the restoration of each access route, and/or work area. Restoration items include, but are not limited to:

- Stone construction entrances and stone spread on route will be removed in accordance with state and federal regulations, applicable permits, and/or at the request of the landowner.
- Temporary routes will be rough-graded to restore preexisting contours.
- All fixed erosion controls, construction matting and temporary bridges will be removed once the site is appropriately stabilized, or upon completion of the work.
- Significant compacted or impervious soil may need to be scarified to restore soil permeability, as needed.
- Disturbed soil will be appropriately stabilized with seed and mulch to promote vegetative cover. Once the area has been restored and vegetation is fully established, a final site visit should be performed, adequately documented (along with photos) and filed in the Project folder or with the VELCO Environmental Team.

A-7 Unanticipated Discovery Response Procedure

Summary:

Although most Project areas have been assessed for the presence of protected resources in advance of Work, numerous variables during construction could potentially reveal previously unidentified features.

Examples of such items include:

- Rare, Threatened or Endangered Species (RTE) – A potential animal nest den or other habitat area, cluster or specimen of plants or animals believed to be protected by the projects permits, plans, or state or federal statute.
- Historic Sites – Human remains, buried artifacts (arrowheads, pottery etc.) or alignments of stone with one or more right-angled corners or depressions such as wells lined with stone or brick.
- Wetlands/Streams – An area of water, saturated soils, and wetland vegetation or area of concentrated flow.

If a work area is discovered to potentially contain protected resources by field personnel, the following process shall be followed:

- The Environmental Team shall be immediately notified.
- The Environmental Team shall perform a site inspection with construction personnel to discuss avoidance measures.
- If the feature is able to be avoided, the area will be flagged with barrier tape, or similar protective barrier.
- If the feature cannot be avoided, the inspector will perform a review to determine if the area was previously assessed.
- A professional may be consulted on the items discovered. Following the expert review, any further field assessment and agency notifications will be made depending on the findings of the assessment.

ATTACHMENT B

Environmental Inspections & Reporting

B-1 Environmental Inspection and Compliance Report

B-2 Environmental Incident Report

B-3 Environmental Change Review Form



B-1 VELCO ENVIRONMENTAL COMPLIANCE AND INSPECTION REPORT

| | | |
|--|--|-----------------|
| PROJECT NAME | | PERMIT NUMBERS: |
| INSPECTOR(S) TITLE & QUALIFICATION | | |
| DATE: | | DISTRIBUTION: |
| CURRENT WEATHER CONDITIONS: | | |
| WEATHER CONDITIONS SINCE LAST INSPECTION: | | |
| | | |
| 1. CONSTRUCTION STATUS: | | |
| STR # | DESCRIPTION OF CONSTRUCTION STATUS | |
| | | |
| | | |
| | | |
| 2. EROSION PREVENTION AND SEDIMENT CONTROL (EPSC) MEASURES: | | |
| STR # | DESCRIPTION OF EPSC MEASURES IMPLEMENTED | |
| | | |
| | | |
| | | |
| 3. NEW EPSC MEASURES UNDERTAKEN SINCE PRIOR REPORT: | | |
| STR # | DESCRIPTION OF NEW EPSC MEASURES IMPLEMENTED | |
| | | |
| | | |
| | | |
| 4. EROSION PROBLEMS, RESOLUTIONS AND OTHER RECOMMENDATIONS: | | |
| STR # | DESCRIPTION | |
| | | |
| | | |
| | | |
| 5. PROJECT STATUS/CONSISTENCY WITH PLANNED CONSTRUCTION SEQUENCE: | | |
| STR # | DESCRIPTION OF CONSTRUCTION PROGRESS | |
| | | |
| | | |
| | | |
| 6. DISTURBED AREAS AT TIME OF INSPECTION: | | |
| STR # | DESCRIPTION OF DISTURBED AREA | |
| | | |
| | | |
| | | |



B-2
VELCO ENVIRONMENTAL INCIDENT REPORT FORM

Project:

Date/Day/Time:

Weather Conditions:

Location (Structure#)

On-site Personnel:

Description of Incident (include description of resource area (wetlands, etc.) :

Necessary Corrective Actions (by Whom/Date/Time):

VELCO Contacts Made (by Whom/Date/Time):

Follow-up Field Inspection (by Whom/Date/Time):

Additional Corrective Actions (by Whom/Date/Time):

Provide Sketch of Incident Area Including:

1) North Arrow:

3) Impact Area

5) Nearby Roadways

2) Structure #

4) Location of equipment

6) Location of Proposed Corrective Actions

7) Wetlands/Streams

8) Access Route

Drawn By:

Date/Day



ENVIRONMENTAL CHANGE REVIEW FORM

Change No.:

| | | |
|--|---------------|----------------|
| Requester: | Date: | |
| Project Location (e.g. structure #., substation) | Project Name: | Work Order No. |

Reason for Change (circle all that apply)

| | | | |
|---------------|--------------------|-------|--------|
| Construction | Environmental Team | Legal | Design |
| Landowner/ROW | Landowner | Other | |

Type of Change (circle all that apply)

| | | | |
|--------------------|---------------|--------------------------------|----------------------|
| Structure Type | Landscaping | Site Plan/Limit of Disturbance | Access Road |
| Structure Location | Tree Clearing | Subterranean | Substation Equipment |
| Other | | | |

Description (to be completed by Requestor – add additional sheets/drawings as necessary):

Environmental Team Review (attach Env. Change Review Form):
 NOTES (provide comments/status on actions necessary before change can be approved) :

Resource Evaluation (circle when resource has been evaluated – use back of form for additional commentary)

| | | | |
|------------|----------|---------------------|-------|
| Archeology | RTE/RINA | Ditch/Stream/River | Other |
| Wetland | EPSC/CGP | VTRANS/Railroad/FAA | |

Drawing Updates Required: (circle all that apply)

| | | | | |
|----------------|----------------------|------------------|---------------------|-------|
| Plan & Profile | Landscape Mitigation | Compliance Plans | Plan Book Amendment | Other |
|----------------|----------------------|------------------|---------------------|-------|

Required Submittals/Actions (if none, circle and insert NA)

| | | | |
|-----|-----|---------|-------|
| DPS | PSB | DPS/PSB | OTHER |
|-----|-----|---------|-------|

Notes: (provide additional comments/instructions/conditions of approval:

APPROVALS

| | | | | |
|-------------------------|-----------|----------------------|--------------|-----------|
| REQUESTOR | | CONSTRUCTION MANAGER | | |
| PRINTED NAME | SIGNATURE | DATE | PRINTED NAME | SIGNATURE |
| COMPLIANCE LEAD | | PROJECT MANAGER | | |
| PRINTED NAME | SIGNATURE | DATE | PRINTED NAME | SIGNATURE |
| ENVIRONMENTAL TEAM LEAD | | | | |
| PRINTED NAME | SIGNATURE | DATE | | |

Procedure:
 1. This form is to be used by the Env. Team to ensure that protected resources are properly evaluated, and if necessary, permits and; compliance plans are amended, before changes are executed in the field.
 2. A change shall not be approved until this form is signed by the Environmental Team Lead, and f necessary the CM and PM, and a copy returned to the Requestor.
 3. Construction and Project Manager signatures required for all permit amendment submittals.

ATTACHMENT C

Typical Best Management Practice Drawings

RIGHT-OF-WAY ACCESS:

| | |
|---------------------------------|----------|
| Construction Entrance Typical | No. RA-1 |
| Water Bar Typical | No. RA-2 |
| Water Diversion Channel Typical | No. RA-3 |
| Crane Pad Typical | No. RA-4 |
| Access Road Typical | No. RA-5 |

WETLAND AND STREAM CROSSINGS:

| | |
|--|------------|
| Construction Mat Typical | No. WS-1 |
| Construction Mat Wetland Bridging Option Typical | No. WS-3 |
| Construction Mat Wetland Bridging Option Alt. #1 | No. WS-3.1 |

EROSION CONTROLS:

| | |
|-------------------------------------|------------|
| Silt Fence Typical | No. EC-1 |
| Silt Fence – Perimeter Typical | No. EC-2 |
| Silt Fence – One Slope Typical | No. EC-3 |
| Silt Fence – Two Slope Typical | No. EC-4 |
| Hay Bale Dike Typical | No. EC-5 |
| Typical Stone Check Dam | No. EC-6 |
| Alternate Check Dam Typical | No. EC-6.1 |
| Tracking & Mulch Anchoring Typical | No. EC-7 |
| Erosion Control Matting Typical | No. EC-8 |
| Channel Installation Typical | No. EC-9 |
| Stone Discharge Apron Typical | No. EC-10 |
| Stone Inlet Protection Typical | No. EC-11 |
| Dewatering Basin Typical | No. EC-12 |
| Reinforced Dewatering Basin Typical | No. EC-13 |
| Concrete Waste Sump Typical | No. EC-14 |
| Barrier Fence Typical | No. EC-15 |

VELCO ENVIRONMENTAL GUIDANCE MANUAL

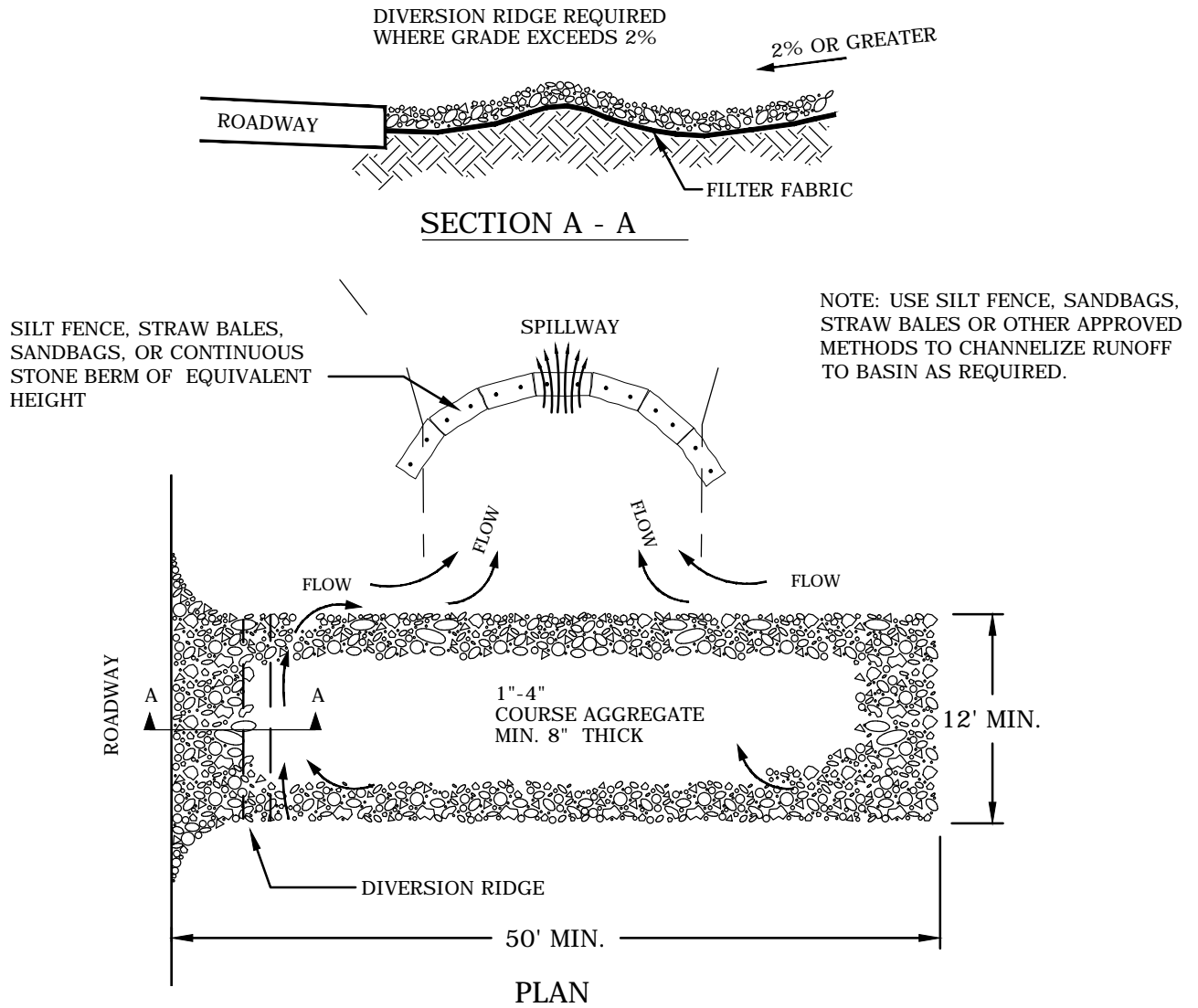

NOTES:

1. USE 1" - 4" STONE AT 8" DEPTH, MINIMUM.
2. THE ENTRANCE SHALL BE MAINTAINED IN A CONDITION THAT WILL PREVENT TRACKING OR FLOWING OF SEDIMENT ONTO ROADWAY. THIS MAY REQUIRE TOP DRESSING AND REPAIR, AND/OR CLEAN OUT OF ANY MEASURES USED TO TRAP SEDIMENT.
3. PERFORM ROUTINE INSPECTIONS AND MAINTENANCE, AS NEEDED.
4. WHEN NECESSARY, WHEELS SHALL BE CLEANED PRIOR TO ENTRANCE ONTO PUBLIC RIGHT-OF-WAY.
5. WHEN WASHING IS REQUIRED, IT SHALL BE DONE ON AN AREA STABILIZED WITH CRUSHED STONE THAT DRAINS INTO AN APPROVED SEDIMENT TRAP OR SEDIMENT BASIN.
6. ALL CHANNELIZED WATER FLOWING TOWARD THE CONSTRUCTION ENTRANCE SHALL BE PIPED BENEATH THE ENTRANCE.



VERMONT ELECTRIC POWER COMPANY, INC.
366 PINNACLE RIDGE ROAD
RUTLAND, VERMONT 05701

STABILIZED CONSTRUCTION ENTRANCE TYPICAL

DATE: 7/11/11

REV:

REF:

RA-1

VELCO ENVIRONMENTAL GUIDANCE MANUAL

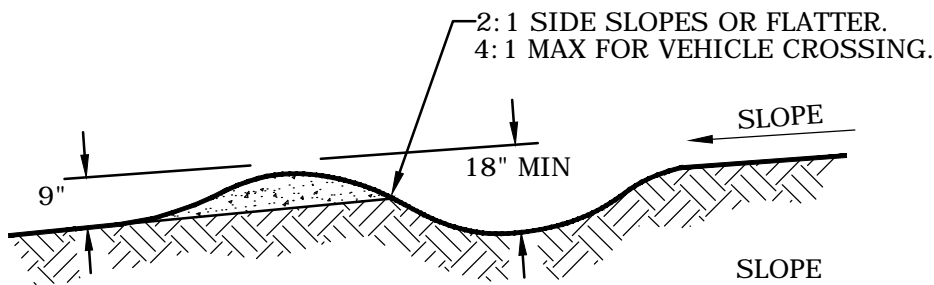
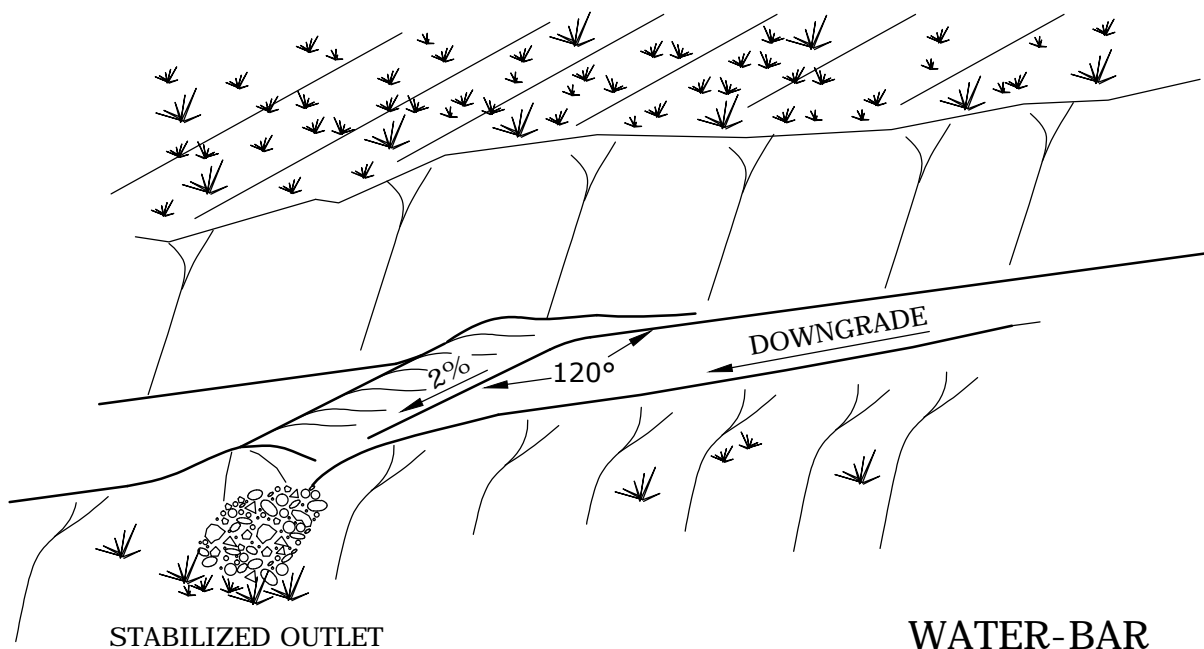

SECTION

| SLOPE | SPACING |
|---------|---------|
| < 5 | 125 |
| 5 - 10 | 100 |
| 10 - 20 | 75 |
| 20 - 35 | 50 |
| > 35 | 25 |

CONSTRUCTION NOTES:

1. INSTALL THE WATER BAR AS NEEDED.
2. TRACK THE RIDGE OF THE WATER BAR TO COMPACT IT TO THE DESIGN CROSS SECTION.
3. THE OUTLET SHALL BE LOCATED ON AN UNDISTURBED AREA. FIELD SPACING WILL BE ADJUSTED TO USE THE MOST STABLE OUTLET AREAS. OUTLET PROTECTION WILL BE PROVIDED WHEN NATURAL CONDITIONS ARE NOT ADEQUATE.
4. INSPECT WATER BARS FOR EROSION DAMAGE AND SEDIMENT. CHECK OUTLET AREAS AND MAKE REPAIRS AS NEEDED TO RESTORE PROPER OPERATION.
5. VEHICLES CROSSING SHALL BE STABILIZED WITH GRAVEL, AS NEEDED.



VERMONT ELECTRIC POWER COMPANY, INC.
 366 PINNACLE RIDGE ROAD
 RUTLAND, VERMONT 05701

WATER-BAR
 TYPICAL

| |
|---------------|
| DATE: 7/11/11 |
| REV: |
| REF: |
| RA-2 |

VELCO ENVIRONMENTAL GUIDANCE MANUAL

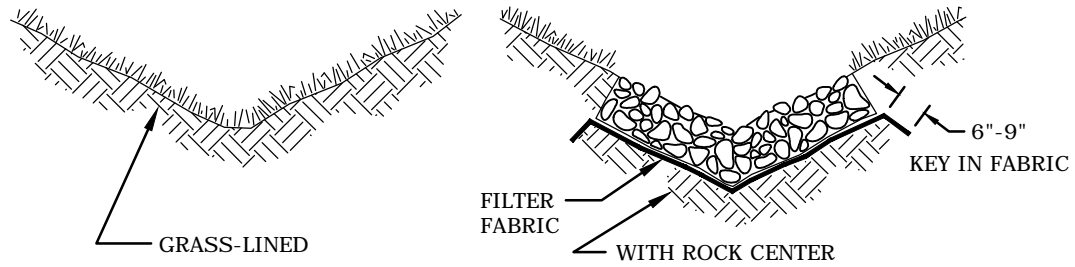

TYPICAL V-SHAPED CHANNEL
CROSS-SECTION

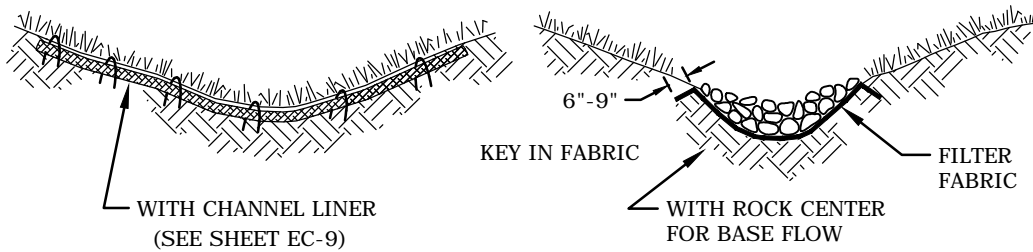

TYPICAL PARABOLIC CHANNEL
CROSS-SECTION

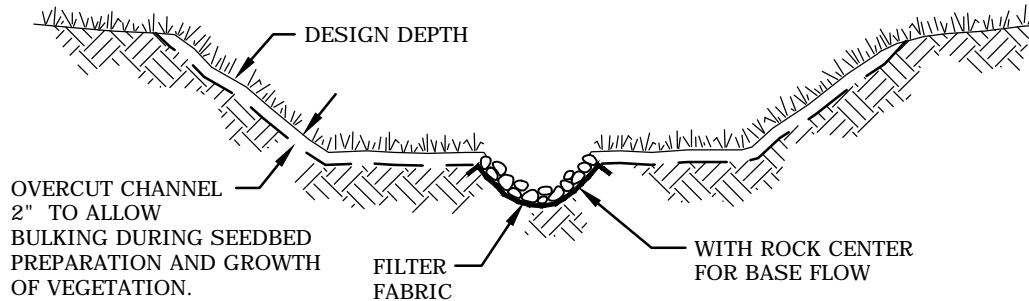

TYPICAL TRAPEZOIDAL CHANNEL
CROSS-SECTION



VERMONT ELECTRIC POWER COMPANY, INC.
366 PINNACLE RIDGE ROAD
RUTLAND, VERMONT 05701

WATER DIVERSION CHANNEL

TYPICALS

DATE: 7/11/11

REV:

REF:

RA-3

VELCO ENVIRONMENTAL GUIDANCE MANUAL

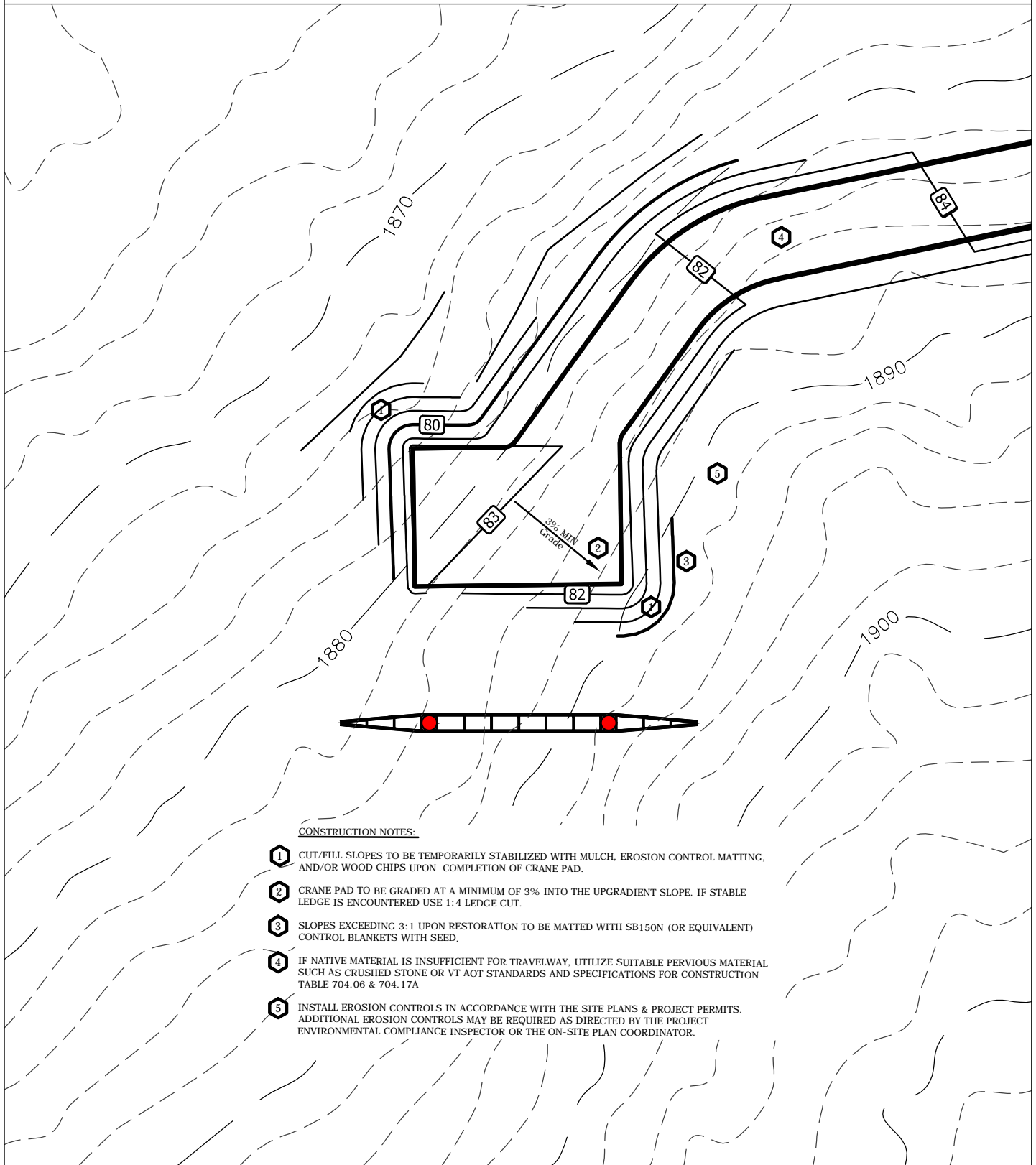

CONSTRUCTION NOTES:

- ① CUT/FILL SLOPES TO BE TEMPORARILY STABILIZED WITH MULCH, EROSION CONTROL MATTING, AND/OR WOOD CHIPS UPON COMPLETION OF CRANE PAD.
- ② CRANE PAD TO BE GRADED AT A MINIMUM OF 3% INTO THE UPGRADIENT SLOPE. IF STABLE LEDGE IS ENCOUNTERED USE 1:4 LEDGE CUT.
- ③ SLOPES EXCEEDING 3:1 UPON RESTORATION TO BE MATTED WITH SB150N (OR EQUIVALENT) CONTROL BLANKETS WITH SEED.
- ④ IF NATIVE MATERIAL IS INSUFFICIENT FOR TRAVELWAY, UTILIZE SUITABLE PERVIOUS MATERIAL SUCH AS CRUSHED STONE OR VT AOT STANDARDS AND SPECIFICATIONS FOR CONSTRUCTION TABLE 704.06 & 704.17A
- ⑤ INSTALL EROSION CONTROLS IN ACCORDANCE WITH THE SITE PLANS & PROJECT PERMITS. ADDITIONAL EROSION CONTROLS MAY BE REQUIRED AS DIRECTED BY THE PROJECT ENVIRONMENTAL COMPLIANCE INSPECTOR OR THE ON-SITE PLAN COORDINATOR.



VERMONT ELECTRIC POWER COMPANY, INC.
366 PINNACLE RIDGE ROAD
RUTLAND, VERMONT 05701

CRANE PAD TYPICAL

DATE: 7/11/11

REV:

REF:

RA-4

VELCO ENVIRONMENTAL GUIDANCE MANUAL

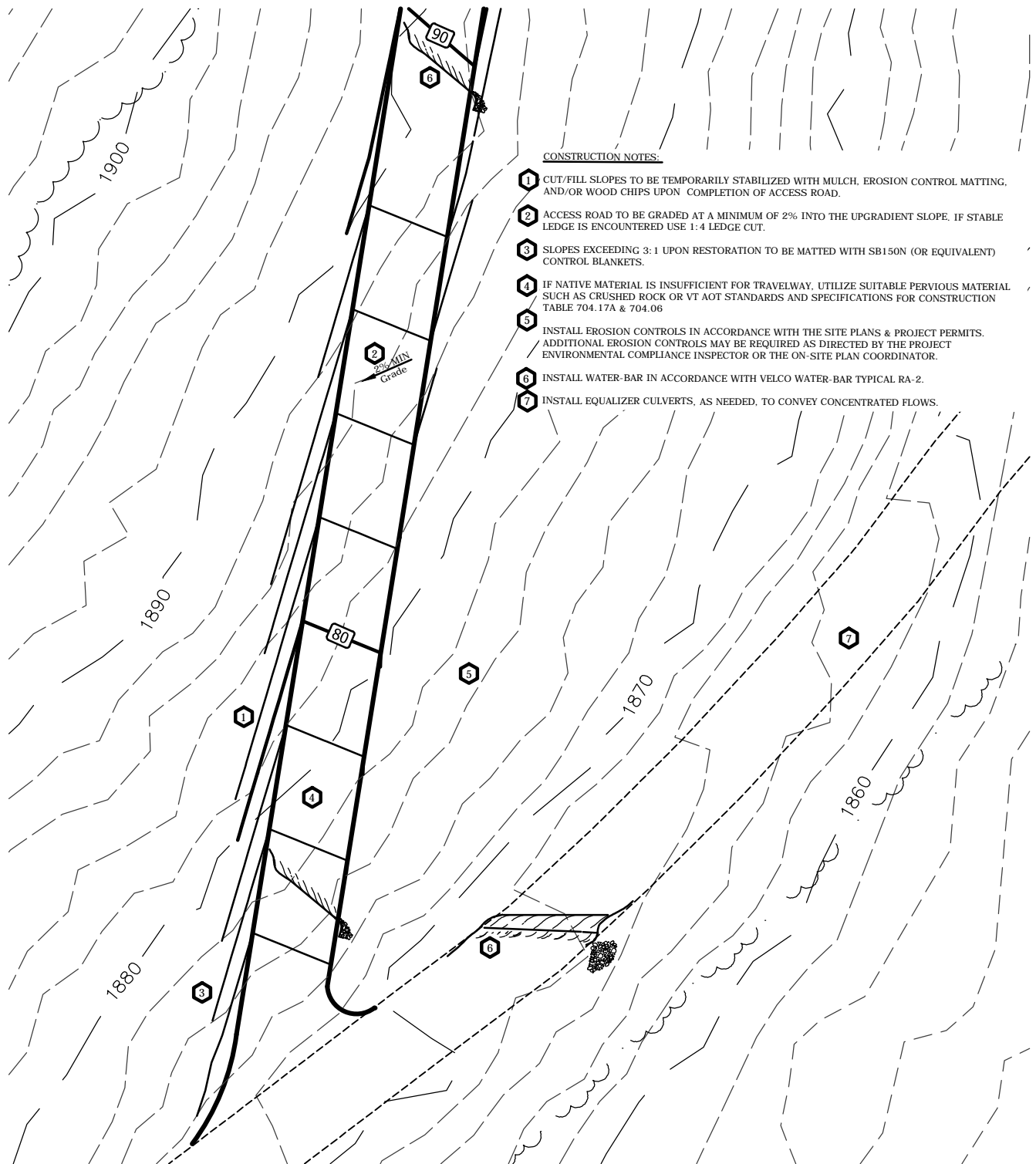

CONSTRUCTION NOTES:

- 1 CUT/FILL SLOPES TO BE TEMPORARILY STABILIZED WITH MULCH, EROSION CONTROL MATTING, AND/OR WOOD CHIPS UPON COMPLETION OF ACCESS ROAD.
- 2 ACCESS ROAD TO BE GRADED AT A MINIMUM OF 2% INTO THE UPGRAIDENT SLOPE. IF STABLE LEDGE IS ENCOUNTERED USE 1:4 LEDGE CUT.
- 3 SLOPES EXCEEDING 3:1 UPON RESTORATION TO BE MATTED WITH SB150N (OR EQUIVALENT) CONTROL BLANKETS.
- 4 IF NATIVE MATERIAL IS INSUFFICIENT FOR TRAVELWAY, UTILIZE SUITABLE PERVIOUS MATERIAL SUCH AS CRUSHED ROCK OR VT AOT STANDARDS AND SPECIFICATIONS FOR CONSTRUCTION TABLE 704.17A & 704.06
- 5 INSTALL EROSION CONTROLS IN ACCORDANCE WITH THE SITE PLANS & PROJECT PERMITS. ADDITIONAL EROSION CONTROLS MAY BE REQUIRED AS DIRECTED BY THE PROJECT ENVIRONMENTAL COMPLIANCE INSPECTOR OR THE ON-SITE PLAN COORDINATOR.
- 6 INSTALL WATER-BAR IN ACCORDANCE WITH VELCO WATER-BAR TYPICAL RA-2.
- 7 INSTALL EQUALIZER CULVERTS, AS NEEDED, TO CONVEY CONCENTRATED FLOWS.

ACCESS ROAD DETAIL

N.T.S.



VERMONT ELECTRIC POWER COMPANY, INC.
366 PINNACLE RIDGE ROAD
RUTLAND, VERMONT 05701

ACCESS ROAD
TYPICAL

DATE: 7/11/11

REV:

REF:

RA-5

VELCO ENVIRONMENTAL GUIDANCE MANUAL

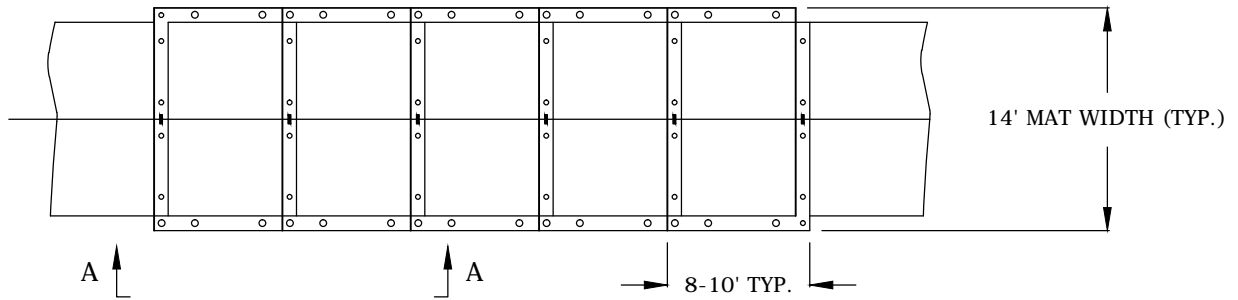

PLAN

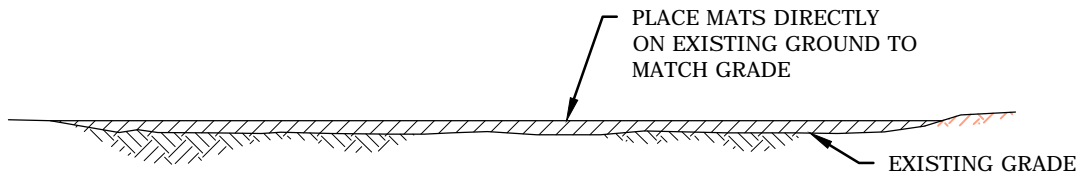

PROFILE

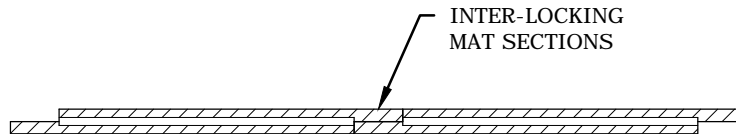

SECTION A-A

TYPICAL HDPE MAT SECTION

NOTES

1. TO BE INSTALLED AS NECESSARY TO MITIGATE WETLAND IMPACTS DURING CONSTRUCTION ACCESS.
2. THIS DETAIL SHOWS TYPICAL MAT DIMENSIONS. MAT MATERIAL TYPICALLY INCLUDES HDPE, TIMBER, OR LAMINATED WOOD. MAT DIMENSIONS MAY BE SLIGHTLY DIFFERENT FROM WHAT IS SHOWN.
3. MATS WILL BE USED AS NEEDED FOR ACCESS AND WORK SPACE AND LABELED AS "TEMPORARY WETLAND IMPACTS" ON WETLAND IMPACT EXHIBIT DRAWINGS; EXCEPT WHERE IN AREAS ACCESS IS SPECIFICALLY SHOWN AS TEMPORARY GRAVEL AND FILTER FABRIC. MATS MAY BE SUBSTITUTED FOR GRAVEL AND FABRIC BUT GRAVEL AND FABRIC SHALL NOT BE SUBSTITUTED FOR MATS.



VERMONT ELECTRIC POWER COMPANY, INC.
366 PINNACLE RIDGE ROAD
RUTLAND, VERMONT 05701

CONSTRUCTION MAT
TYPICAL

DATE: 7/11/11

REV:

REF:

WS-1

VELCO ENVIRONMENTAL GUIDANCE MANUAL

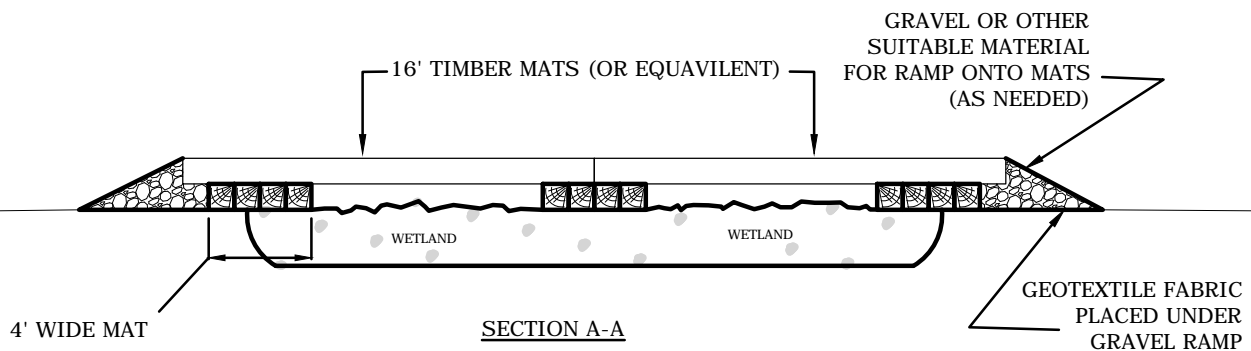
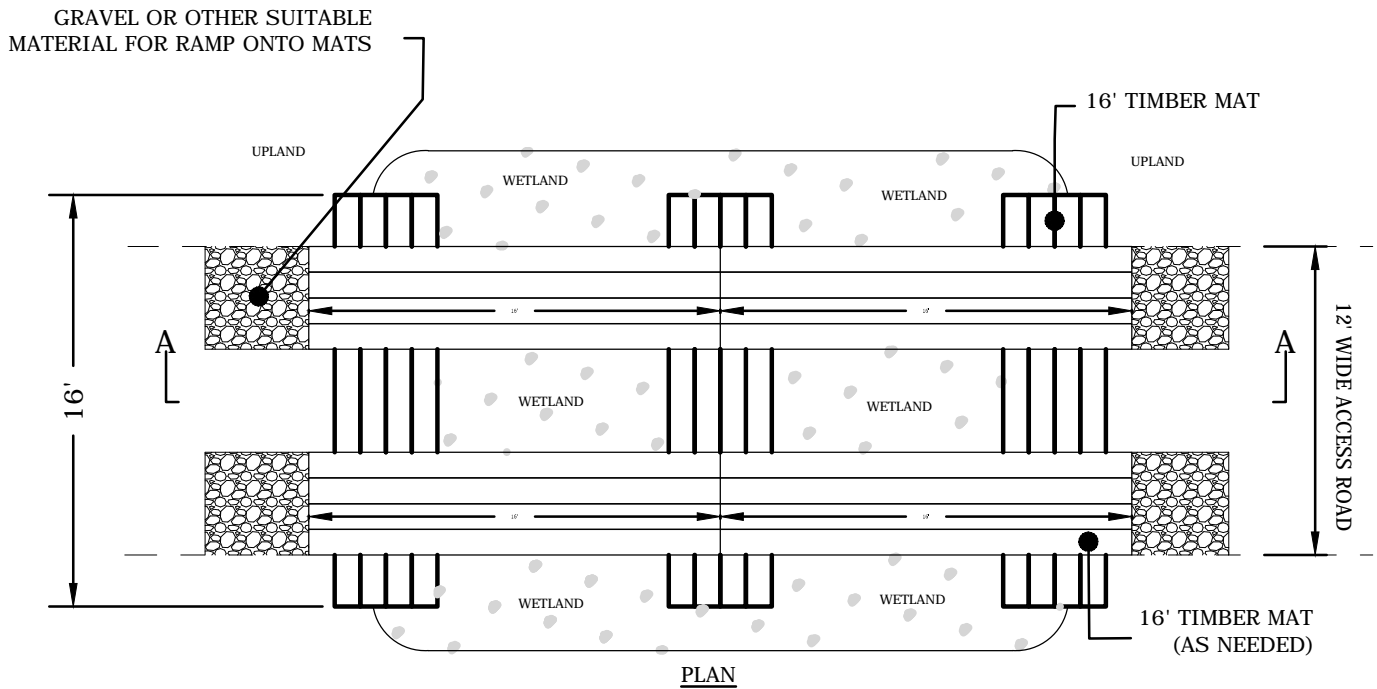

NOTES

1. DEPLOY EROSION CONTROLS AS NEEDED TO MINIMIZE EROSION.
2. PERFORM ROUTINE INSPECTION TO INCLUDE REMOVAL OF LOOSE SOIL TRACKED ONTO MATS BY EQUIPMENT.
3. MATS SHALL BE POSITIONED TO RETAIN THE NATURAL FLOW CHARACTERISTICS.



VERMONT ELECTRIC POWER COMPANY, INC.
366 PINNACLE RIDGE ROAD
RUTLAND, VERMONT 05701

CONSTRUCTION MAT

WETLAND BRIDGING OPTION - TYPICAL

DATE: 7/11/11

REV:

REF:

WS-3

VELCO ENVIRONMENTAL GUIDANCE MANUAL

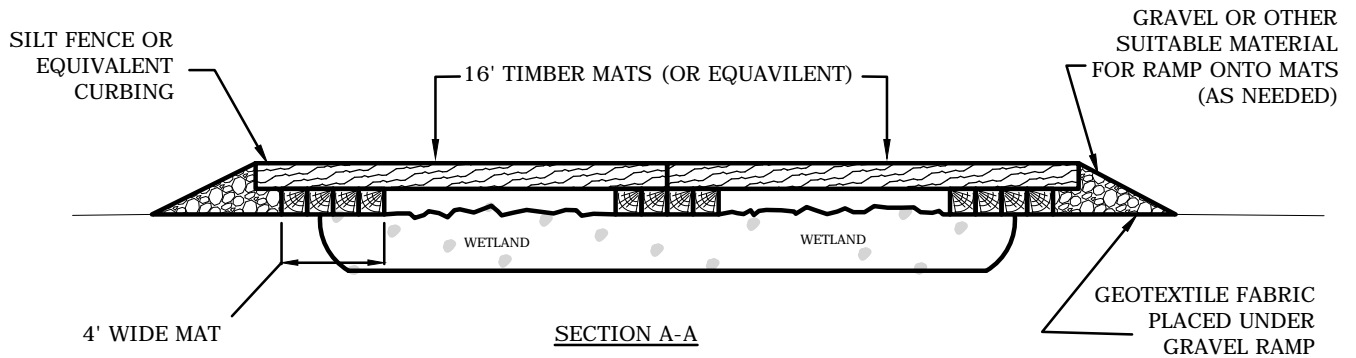
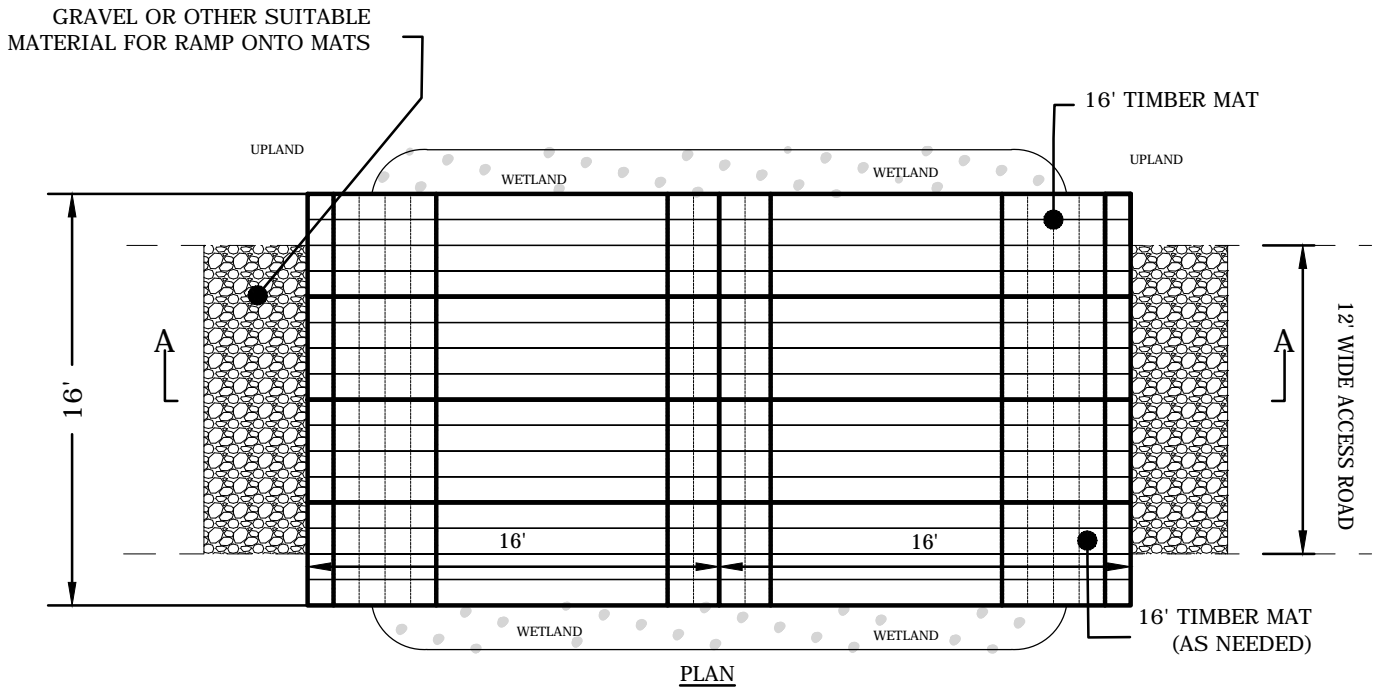

NOTES

1. DEPLOY EROSION CONTROLS AS NEEDED TO MINIMIZE EROSION.
2. PERFORM ROUTINE INSPECTION TO INCLUDE REMOVAL OF LOOSE SOIL TRACKED ONTO MATS BY EQUIPMENT.
3. MATS SHALL BE POSITIONED TO RETAIN THE NATURAL FLOW CHARACTERISTICS.



VERMONT ELECTRIC POWER COMPANY, INC.
366 PINNACLE RIDGE ROAD
RUTLAND, VERMONT 05701

CONSTRUCTION MAT

WETLAND BRIDGING OPTION - ALT #1

DATE: 7/11/11

REV:

REF:

WS-3.1

VELCO ENVIRONMENTAL GUIDANCE MANUAL

NOTES

1. WOVEN WIRE FENCE TO BE FASTENED SECURELY TO FENCE POSTS WITH WIRE TIES. WIRE FENCE REINFORCEMENT REQUIRED WITHIN 100 FT UPSLOPE OF RECEIVING WATERS.
2. FILTER CLOTH TO BE FASTENED SECURELY TO WOVEN WIRE FENCE WITH TIES SPACED EVERY 24" AT TOP AND MID SECTION. FENCE SHALL BE WOVEN WIRE 6" MAXIMUM MESH OPENING.
3. WHEN TWO SECTIONS OF FILTER CLOTH ADJOIN EACH OTHER THEY SHALL BE OVERLAPPED BY SIX INCHES AND FOLDED. FILTER CLOTH SHALL BE EITHER FILTER X, MIRAFI 100X, STABILINKA T140N, OR APPROVED EQUIVALENT.
4. PREFABRICATED UNITS SHALL BE GEOFAB, ENVIFENCE, OR APPROVED EQUIVALENT.
5. MAINTAINANCE SHALL BE PERFORMED AS NEEDED AND MATERIAL REMOVED WHEN SEDIMENTS REACH 1/2 OF FABRIC HEIGHT.

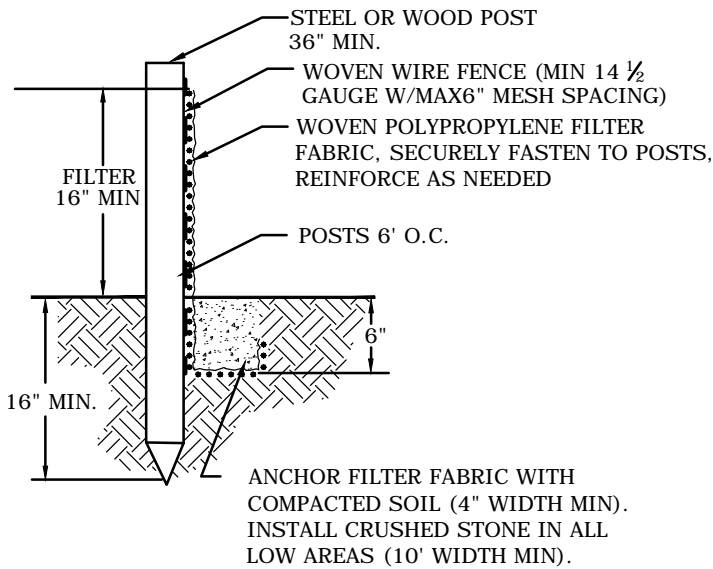
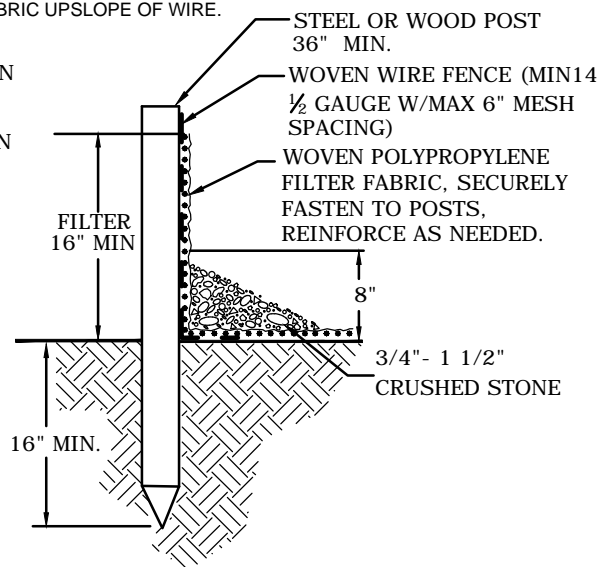
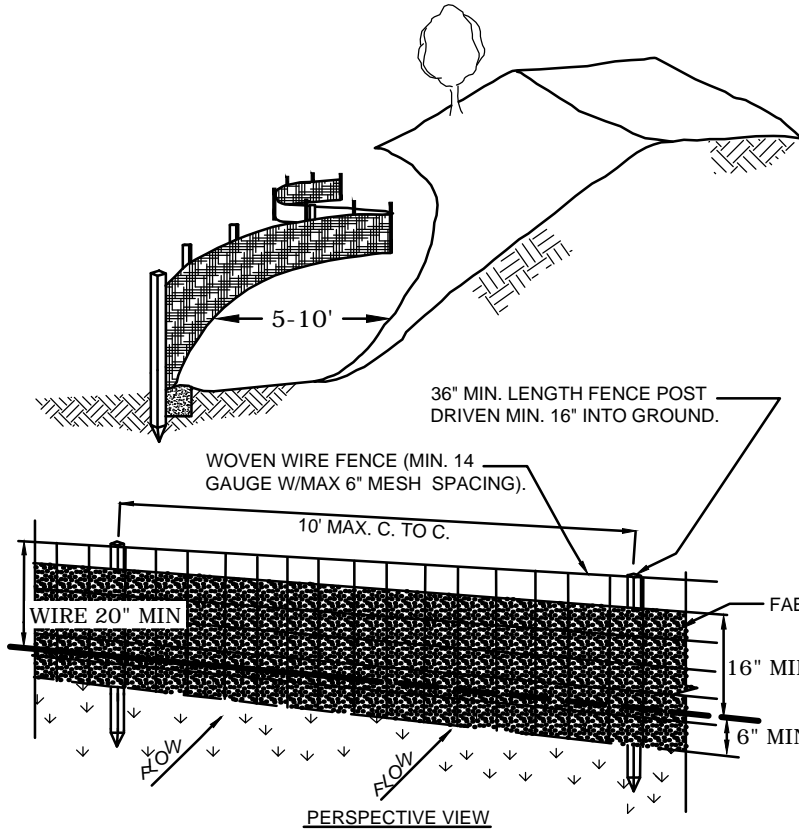

NOTES:

1. THIS INSTALLATION INTENDED FOR LOCATIONS WHERE DIGGING CONTINUOUS FLAP IN 6" NOT POSSIBLE OR DESIRABLE.
2. PROVIDE A WATERTIGHT SEAL BETWEEN EXISTING GRADE AND BASE OF FABRIC.
3. PROVIDE CLEAN WASHED STONE 3/4 - 1 1/2" DIA. TO SECURE SEAL.



VERMONT ELECTRIC POWER COMPANY, INC.
366 PINNACLE RIDGE ROAD
RUTLAND, VERMONT 05701

SILT FENCE
TYPICAL

DATE: 7/11/11

REV:

REF:

EC-1

VELCO ENVIRONMENTAL GUIDANCE MANUAL

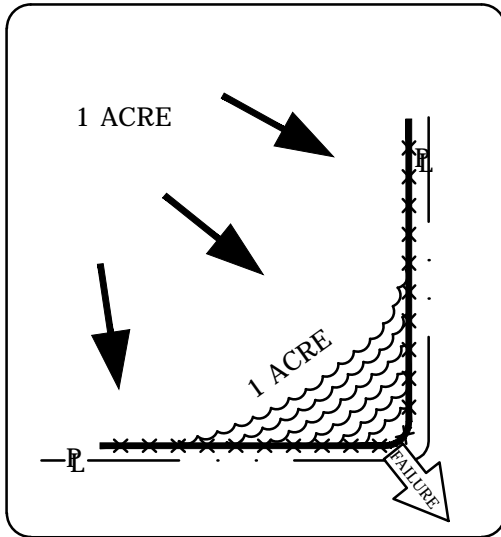

Incorrect - Do Not layout "perimeter control" silt fences along property lines. All sediment laden runoff will concentrate and overwhelm the system.

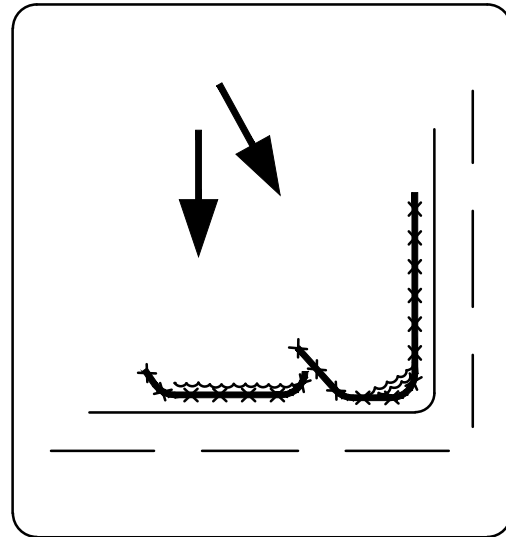

Correct - Install J-hooks

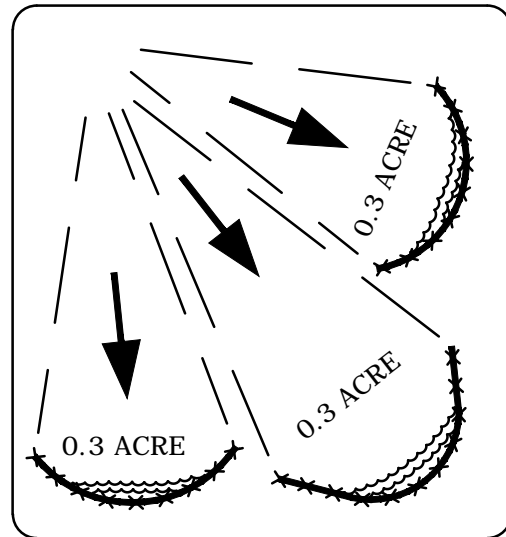
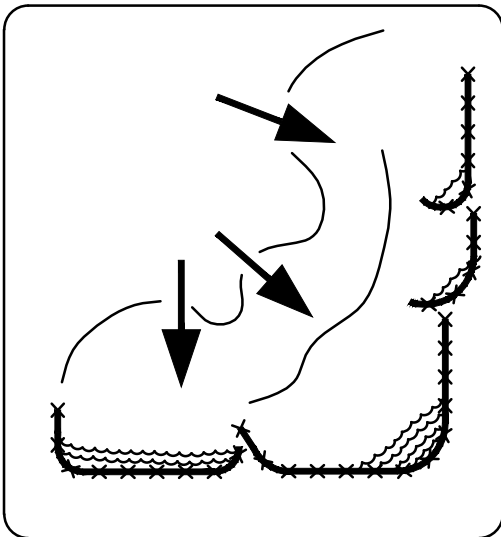

Discreet segments of silt fence, installed with J-hooks or 'smiles' will be more effective.



VERMONT ELECTRIC POWER COMPANY, INC.
366 PINNACLE RIDGE ROAD
RUTLAND, VERMONT 05701

SILT FENCE PERIMETER CONTROL - TYPICAL

DATE: 7/11/11

REV:

REF:

EC-2

VELCO ENVIRONMENTAL GUIDANCE MANUAL

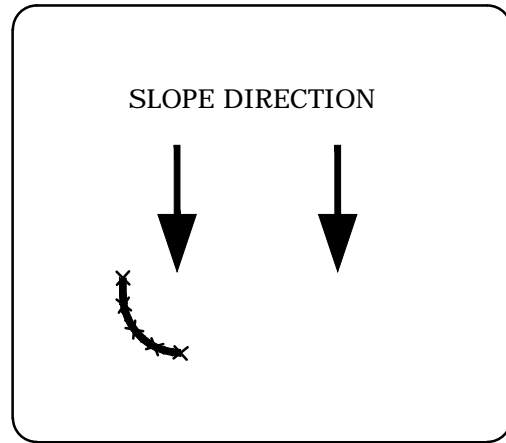
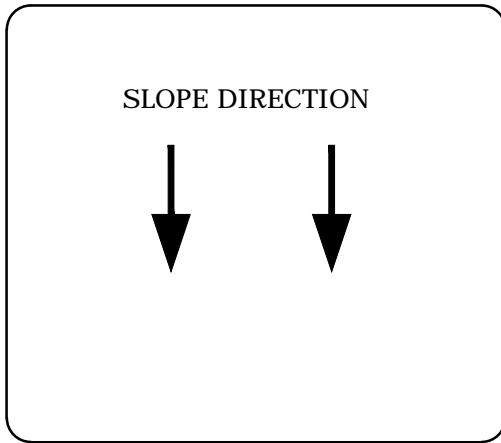

STEP 1 - CONSTRUCT "LEG"

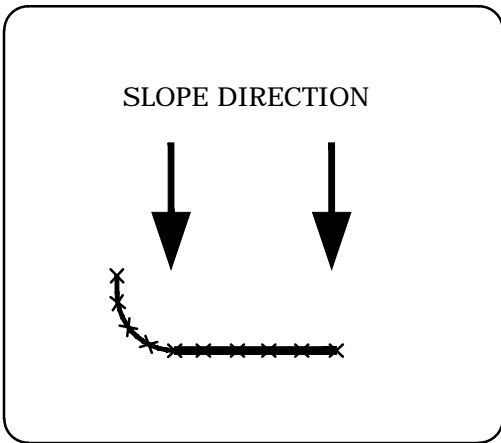

STEP 2 - CONSTRUCT "DAM"

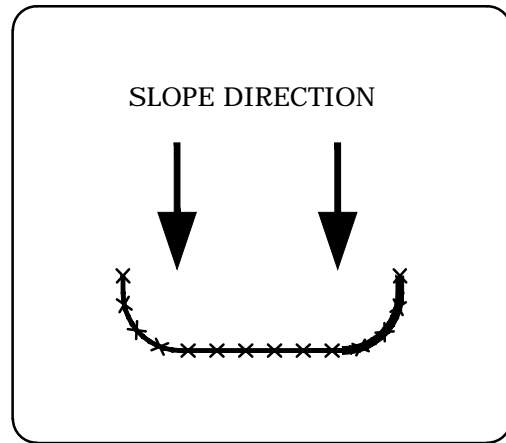

STEP 3 - CONSTRUCT "LEG 2"

INSTALLATION WITH J-HOOKS OR 'SMILES' INCREASE SILT FENCE EFFICIENCY.



VERMONT ELECTRIC POWER COMPANY, INC.
366 PINNACLE RIDGE ROAD
RUTLAND, VERMONT 05701

SILT FENCE
ONE SLOPE - TYPICAL

DATE: 7/11/11

REV:

REF:

EC-3

VELCO ENVIRONMENTAL GUIDANCE MANUAL

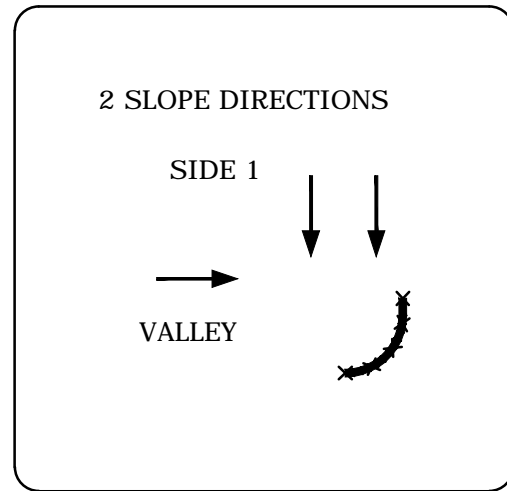
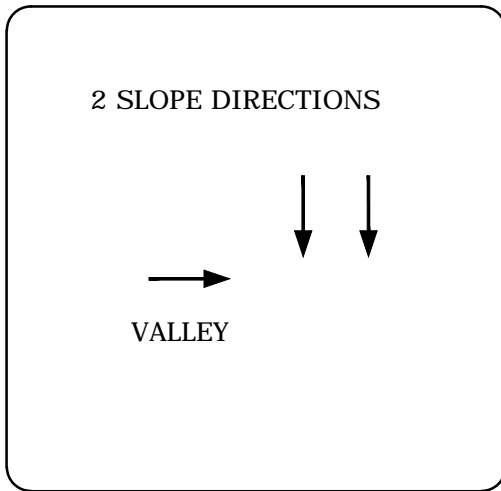

STEP 1 - CONSTRUCT A "DAM"

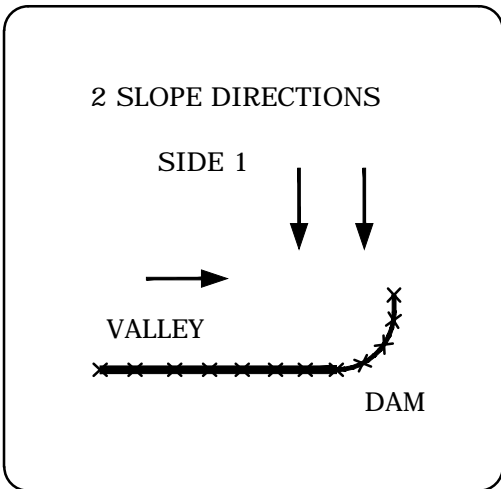

STEP 2 - CONSTRUCT SIDE 2

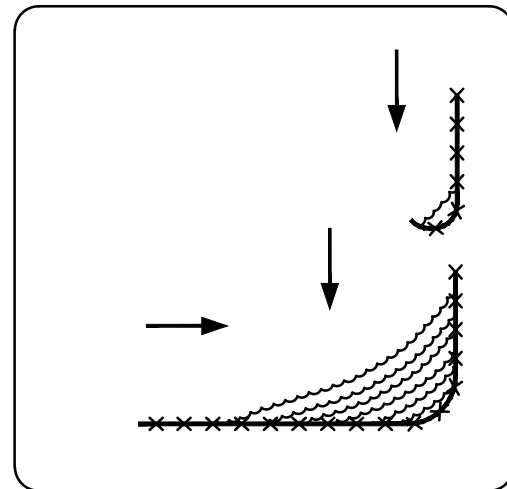

STEP 3 - CONSTRUCT "J-HOOKS"
AS NEEDED

INSTALLATION WITH J-HOOKS WILL INCREASE SILT FENCE EFFICIENCY AND REDUCE EROSION-CAUSING FAILURES.



VERMONT ELECTRIC POWER COMPANY, INC.
366 PINNACLE RIDGE ROAD
RUTLAND, VERMONT 05701

SILT FENCE

TWO SLOPES - TYPICAL

DATE: 7/11/11

REV:

REF:

EC-4

VELCO ENVIRONMENTAL GUIDANCE MANUAL

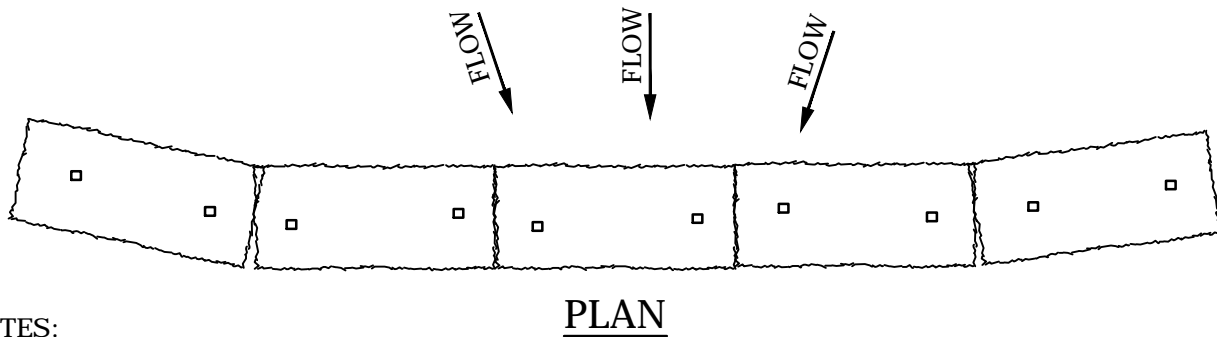
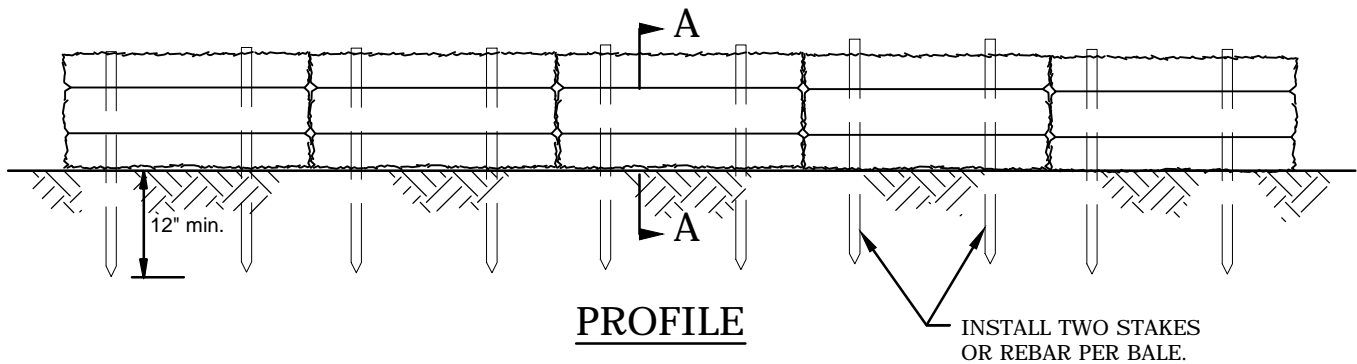
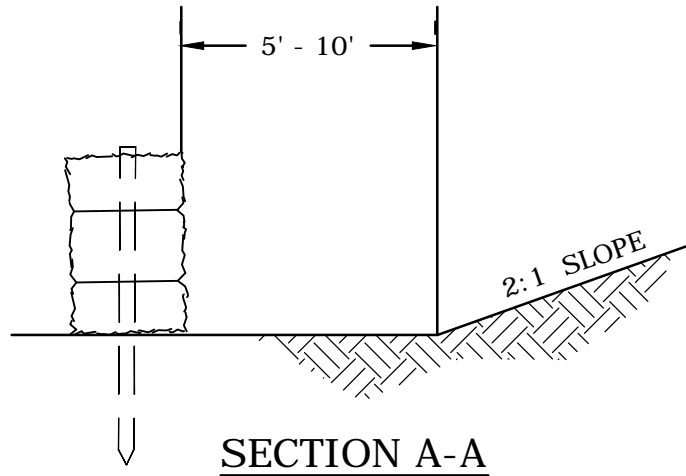

NOTES:

1. THE HAYBALES SHALL BE PLACED ON SLOPE CONTOUR, BUT NOT IN AREAS OF CONCENTRATED FLOW.
2. BALES TO BE PLACED IN A ROW WITH THE ENDS TIGHTLY ABUTTING.
3. TO BE USED IN WETLANDS OR OTHER AREAS WHERE SILT FENCE INSTALLATION MAY CAUSE ADDITIONAL WETLAND IMPACT.
4. IN AREAS OF LIMITED SOIL DISTURBANCE, BALES MAY BE REMOVED AND BROADCAST AS MULCH UPON COMPLETION OF WORK.
5. IF STEEL REBAR IS USED (FROZEN CONDITIONS), INSTALL SAFETY CAP.



VERMONT ELECTRIC POWER COMPANY, INC.
366 PINNACLE RIDGE ROAD
RUTLAND, VERMONT 05701

HAYBALE DIKE

TYPICAL

DATE: 7/11/11

REV:

REF:

EC-5

VELCO ENVIRONMENTAL GUIDANCE MANUAL

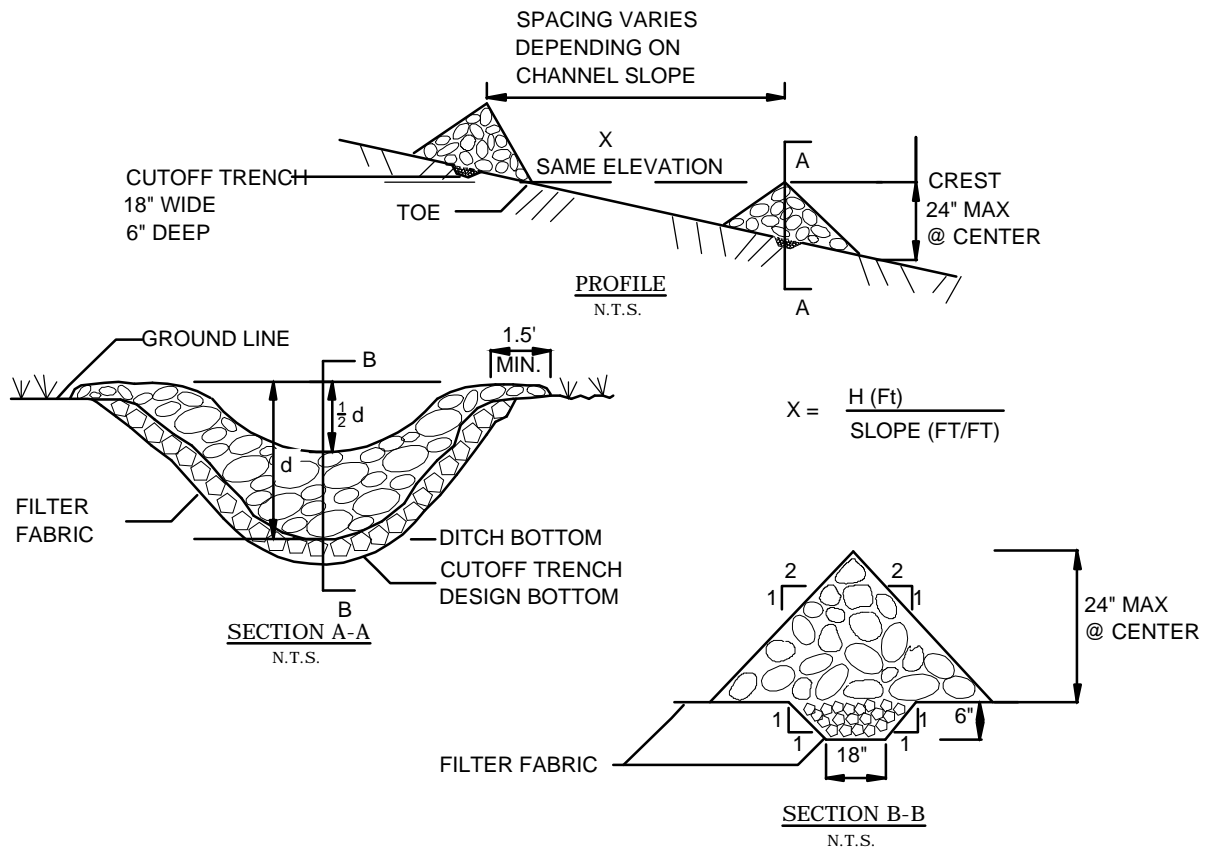

NOTES:

1. STONE WILL BE PLACED ON A FILTER FABRIC FOUNDATION TO THE LINES, GRADES AND LOCATIONS SHOWN IN THE PLAN.
2. SET SPACING OF CHECK DAMS TO ASSUME THAT THE ELEVATIONS OF THE CREST OF THE DOWNSTREAM DAM IS AT THE SAME ELEVATION OF THE TOE OF THE UPSTREAM DAM.
3. EXTEND THE STONE A MINIMUM OF 1.5 FEET BEYOND THE DITCH BANKS TO PREVENT CUTTING AROUND THE DAM.
4. PROTECT THE CHANNEL DOWNSTREAM OF THE LOWEST CHECK DAM FROM SCOUR AND EROSION WITH STONE OR LINER AS NEEDED.
5. USE WELL GRADED STONE 2" - 9" IN SIZE.
6. SEDIMENT SHOULD BE REMOVED FROM BEHIND THE CHECK DAM ONCE THE ACCUMULATED HEIGHT HAS REACHED ONE-HALF THE HEIGHT OF THE CHECK DAM, STABILIZE AS SOON AS POSSIBLE.



VERMONT ELECTRIC POWER COMPANY, INC.
366 PINNACLE RIDGE ROAD
RUTLAND, VERMONT 05701

STONE CHECK DAM TYPICAL

DATE: 7/11/11

REV:

REF:

EC-6

VELCO ENVIRONMENTAL GUIDANCE MANUAL

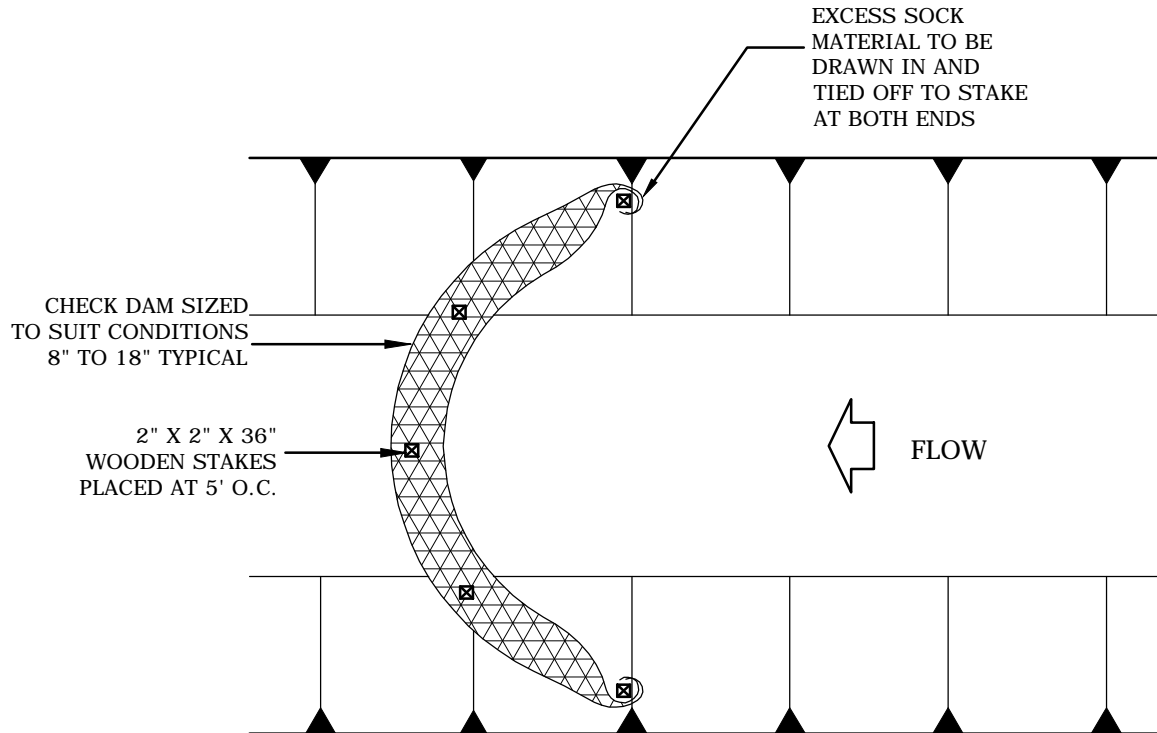

NOTES:

1. ALL MATERIAL TO MEET FILTREXX® (OR EQUIVALENT MANUFACTURER) SPECIFICATIONS.
2. CHECK DAM SHOULD BE USED IN AREAS THAT DRAIN 10 ACRES OR LESS.
3. SEDIMENT SHOULD BE REMOVED FROM BEHIND THE CHECK DAM ONCE THE ACCUMULATED HEIGHT HAS REACHED ONE-HALF THE HEIGHT OF THE CHECK DAM, STABILIZE AS SOON AS POSSIBLE.
4. CHECK DAM CAN BE DIRECT SEEDED AT THE TIME OF INSTALLATION.



VERMONT ELECTRIC POWER COMPANY, INC.
366 PINNACLE RIDGE ROAD
RUTLAND, VERMONT 05701

ALTERNATE CHECK DAM TYPICAL

DATE: 7/11/11

REV:

REF:

EC-6.1

VELCO ENVIRONMENTAL GUIDANCE MANUAL

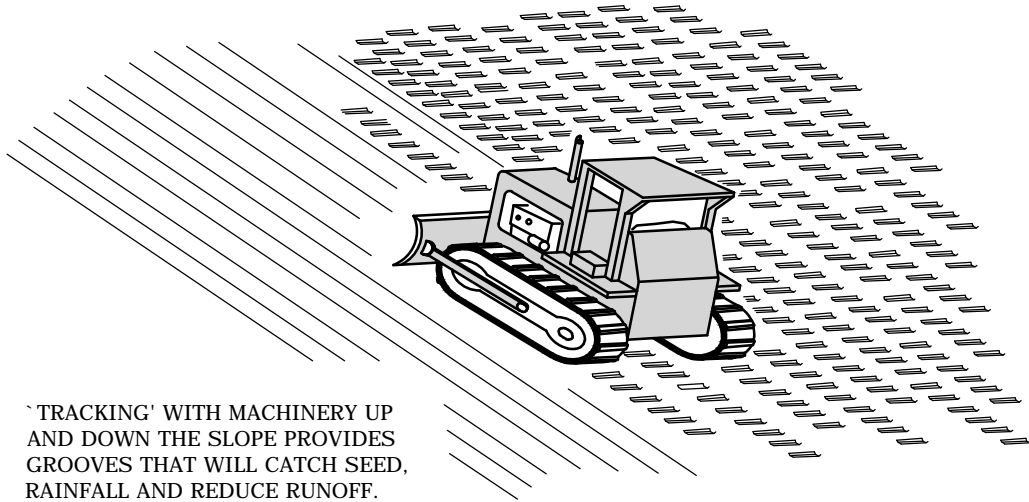

“TRACKING” WITH MACHINERY UP AND DOWN THE SLOPE PROVIDES GROOVES THAT WILL CATCH SEED, RAINFALL AND REDUCE RUNOFF.

SEED BED PREPARATION



NOTES:

1. ROUGHEN SLOPE WITH TRACKED MACHINE.
2. BROADCAST SEED AND FERTILIZER. (TYPE OF FERTILIZER AND SEED TO BE DETERMINED BY VELCO)
3. SPREAD MULCH AT A RATE OF 2 TONS PER ACRE (DOUBLE THE APPLICATION RATE FOR WINTER CONSTRUCTION).
4. PUNCH MULCH INTO SLOPE BY RUNNING TRACKED MACHINE UP AND DOWN SLOPE PERPENDICULAR TO THE CONTOURS.

MULCH ANCHORING



VERMONT ELECTRIC POWER COMPANY, INC.
366 PINNACLE RIDGE ROAD
RUTLAND, VERMONT 05701

TRACKING & MULCH ANCHORING - TYPICAL

DATE: 7/11/11

REV:

REF:

EC-7

VELCO ENVIRONMENTAL GUIDANCE MANUAL

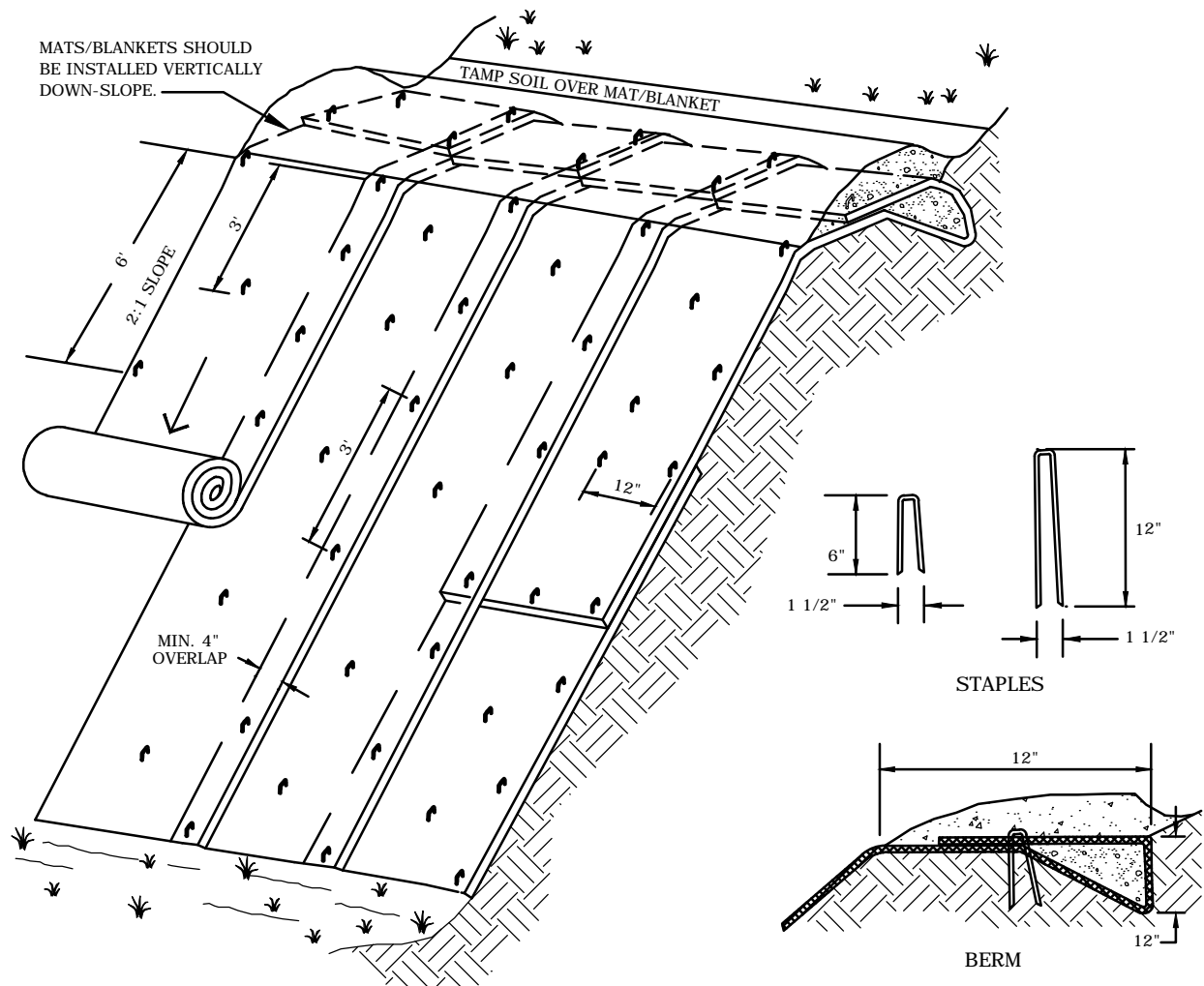

NOTES:

1. SLOPE SURFACE SHALL BE FREE OF ROCKS, LARGE CLODS AND STUMPS. MATS/ BLANKETS SHALL HAVE GOOD SOIL CONTACT.
2. APPLY SEED AND/ OR FERTILIZER, BEFORE PLACING BLANKETS.
3. LAY BLANKETS LOOSELY AND STAKE OR STAPLE TO MAINTAIN DIRECT CONTACT WITH THE SOIL. DO NOT STRETCH.
4. CHECK SLOTS TO BE CONSTRUCTED PER MANUFACTURERS SPECIFICATIONS.
5. STAKING OR STAPLING LAYOUT PER MANUFACTURERS SPECIFICATIONS.



VERMONT ELECTRIC POWER COMPANY, INC.
 366 PINNACLE RIDGE ROAD
 RUTLAND, VERMONT 05701

EROSION CONTROL MATTING INSTALLATION - TYPICAL

DATE: 7/11/11

REV:

REF:

EC-8

VELCO ENVIRONMENTAL GUIDANCE MANUAL

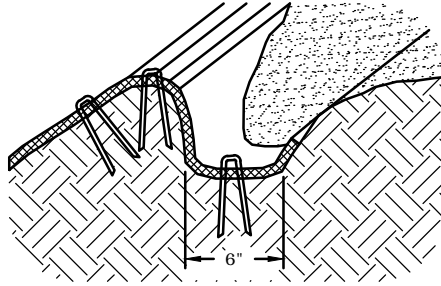

LONGITUDINAL ANCHOR TRENCH

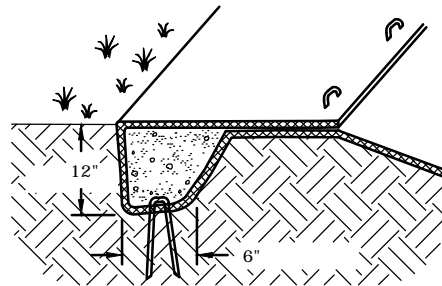

TERMINAL SLOPE AND CHANNEL ANCHOR TRENCH

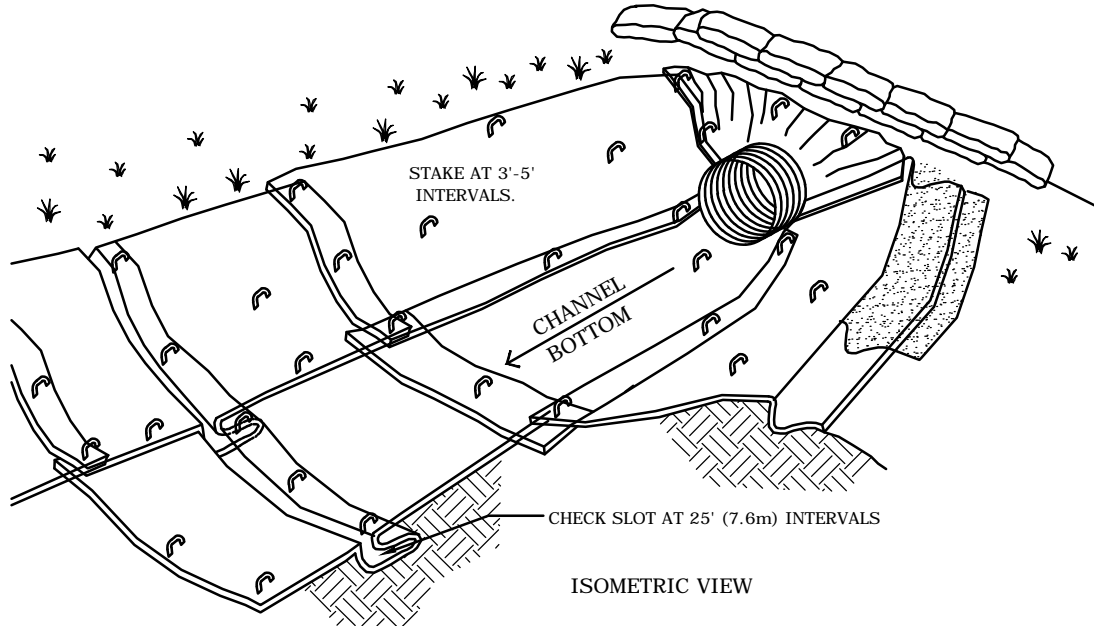

ISOMETRIC VIEW

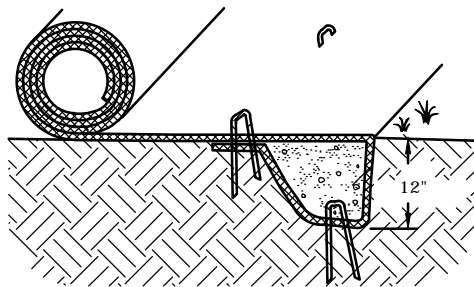

INITIAL CHANNEL ANCHOR TRENCH

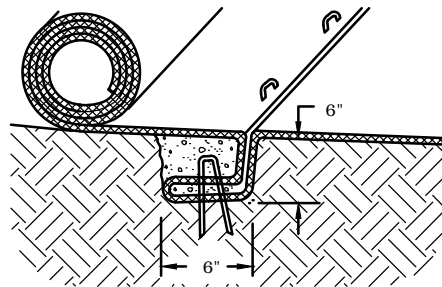

INTERMITTENT CHECK SLOT

NOTES:

1. SLOPE SURFACE SHALL BE FREE OF ROCKS, LARGE CLOUDS AND STUMPS. MATS/ BLANKETS SHALL HAVE GOOD SOIL CONTACT.
2. APPLY SEED AND/ OR FERTILIZER BEFORE PLACING BLANKETS.
3. LAY BLANKETS LOOSELY AND STAKE OR STAPLE TO MAINTAIN DIRECT CONTACT WITH THE SOIL. DO NOT STRETCH.
4. CHECK SLOTS TO BE CONSTRUCTED PER MANUFACTURERS SPECIFICATIONS.
5. STAKING OR STAPLING LAYOUT PER MANUFACTURERS SPECIFICATIONS.



VERMONT ELECTRIC POWER COMPANY, INC.
366 PINNACLE RIDGE ROAD
RUTLAND, VERMONT 05701

EROSION CONTROL MATTING
CHANNEL INSTALLATION (TYP.)

DATE: 7/11/11

REV:

REF:

EC-9

VELCO ENVIRONMENTAL GUIDANCE MANUAL

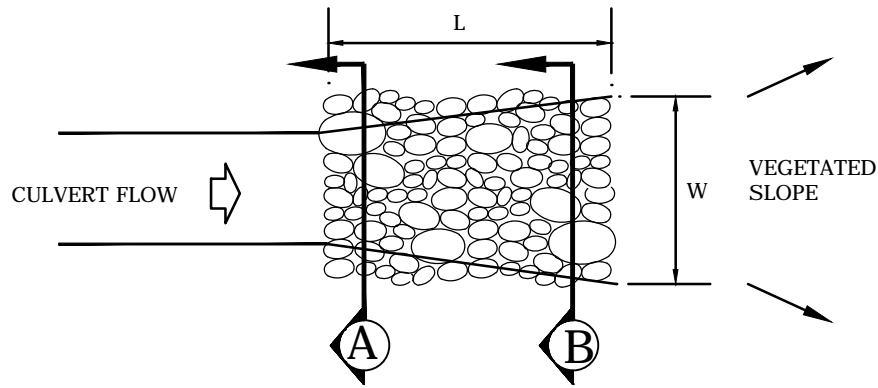

PLAN

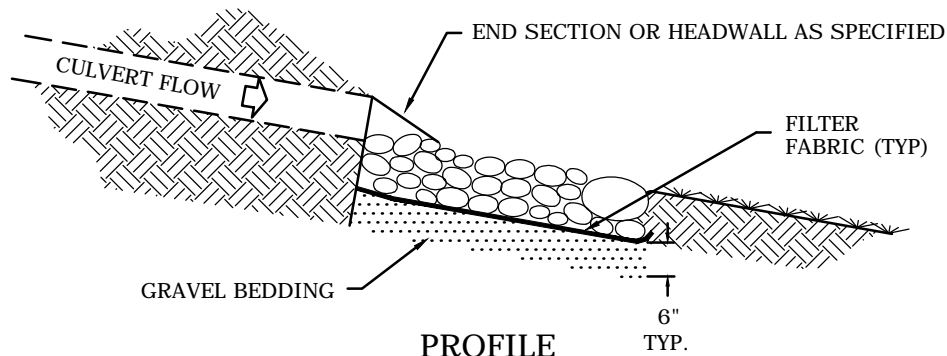

PROFILE

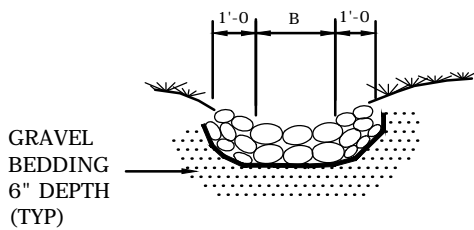

CROSS SECTION

(A)

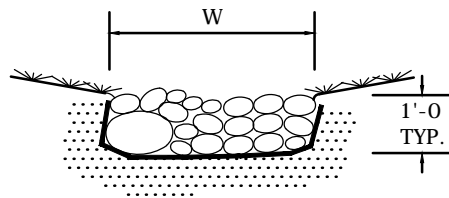

CROSS SECTION

(B)

| PIPE (W) | B (Ft.) | W (Ft.) | L (Ft.) | STONE TYPE |
|-------------|------------|------------|------------|---------------|
| 15" | 2' | 4' | 8' | I |
| 18" | 2' | 4' | 8' | I |
| 24" | 4' | 6' | 12' | II |
| 30" | 4' | 6' | 14' | II |
| 36" | 4' | 6' | 16' | II |
| 42" | 6' | 8' | 18' | II |
| 48" | 6' | 8' | 20' | II |

(USE THESE DIMENSIONS UNLESS OTHERWISE NOTED ON PLAN)



VERMONT ELECTRIC POWER COMPANY, INC.
366 PINNACLE RIDGE ROAD
RUTLAND, VERMONT 05701

STONE DISCHARGE APRON - TYPICAL

DATE: 7/11/11

REV:

REF:

EC-10

VELCO ENVIRONMENTAL GUIDANCE MANUAL

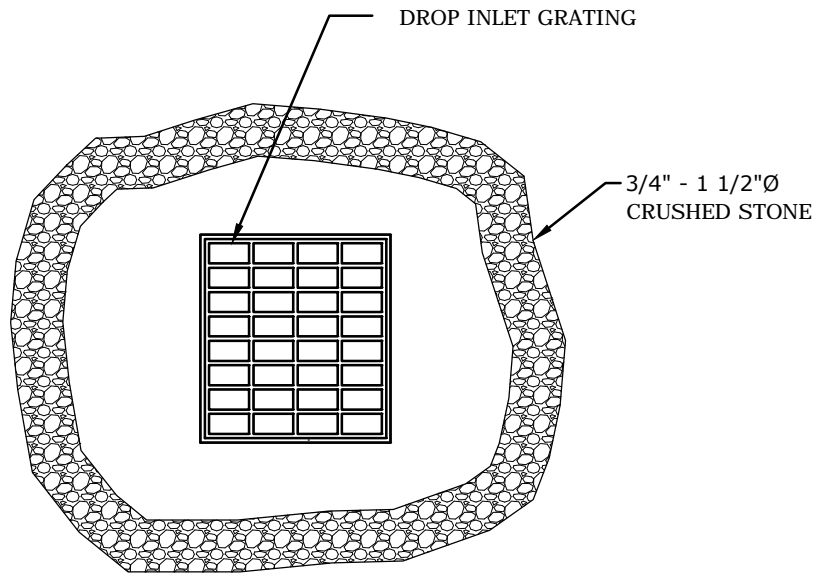

PLAN VIEW

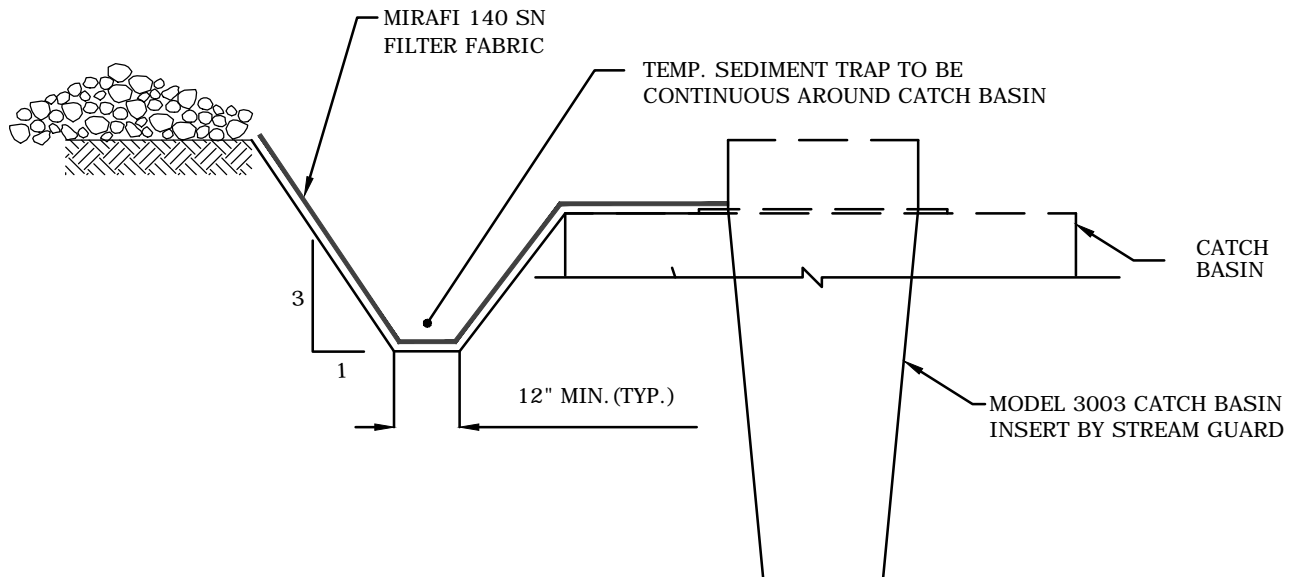

VERMONT ELECTRIC POWER COMPANY, INC.
366 PINNACLE RIDGE ROAD
RUTLAND, VERMONT 05701

STONE INLET PROTECTION TYPICAL

DATE: 7/11/11

REV:

REF:

EC-11

VELCO ENVIRONMENTAL GUIDANCE MANUAL

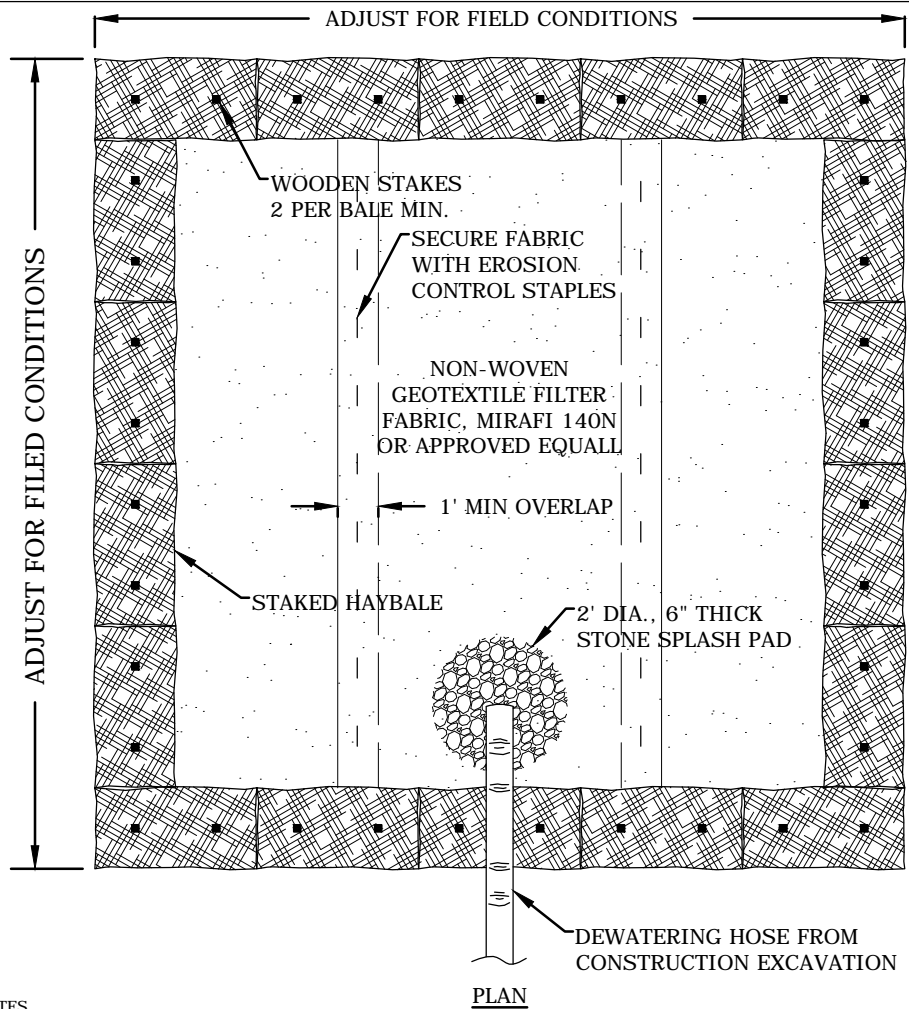

NOTES

1. SIZE OF BASIN AND ASSOCIATED NUMBER OF BALES MAY VARY BASED ON SITE CONDITIONS.
2. THE BASIN SHALL BE SIZED TO PREVENT DISCHARGE WATER FROM OVERTOPPING BASIN. IF BASIN IS OVERTOPPED DISCONTINUE USE IMMEDIATELY AND RE-SIZE.
3. KEEP BASIN AS FAR FROM WETLANDS AS PRACTICAL. DO NOT LOCATE BASIN WITHIN 25 FEET OF WETLANDS OR OTHER RESOURCES
4. BASINS SHALL BE LOCATED IN AREAS THAT ARE GENERALLY FLAT WITH SLOPES FROM 0-2%.
5. USE REINFORCED BASINS AS DETAILED WITH SILT FENCE AND STONE IN AREAS OF CONSIDERABLE FLOW AND FOR BASINS THAT ARE TO BE USED FOR PERIODS LONGER THAN 7 DAYS.
6. CLEAN AND REMOVE BASIN AS SOON AS DEWATERING IS COMPLETE.
7. CONCRETE JERSEY BARRIERS CAN BE SUBSTITUTED FOR HAYBALES AS DESIRED.

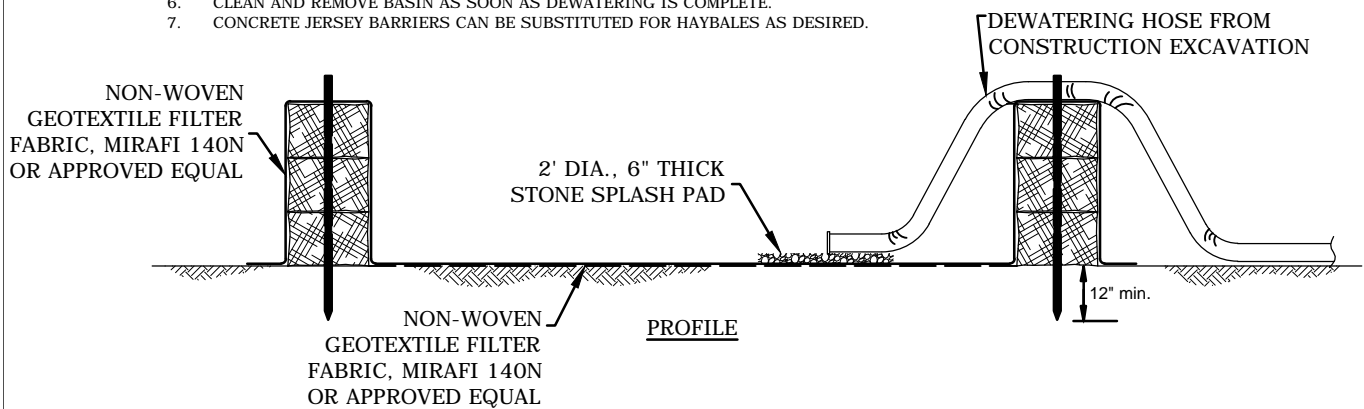

VERMONT ELECTRIC POWER COMPANY, INC.
366 PINNACLE RIDGE ROAD
RUTLAND, VERMONT 05701

DEWATERING BASIN TYPICAL

DATE: 7/11/11

REV:

REF:

EC-12

VELCO ENVIRONMENTAL GUIDANCE MANUAL

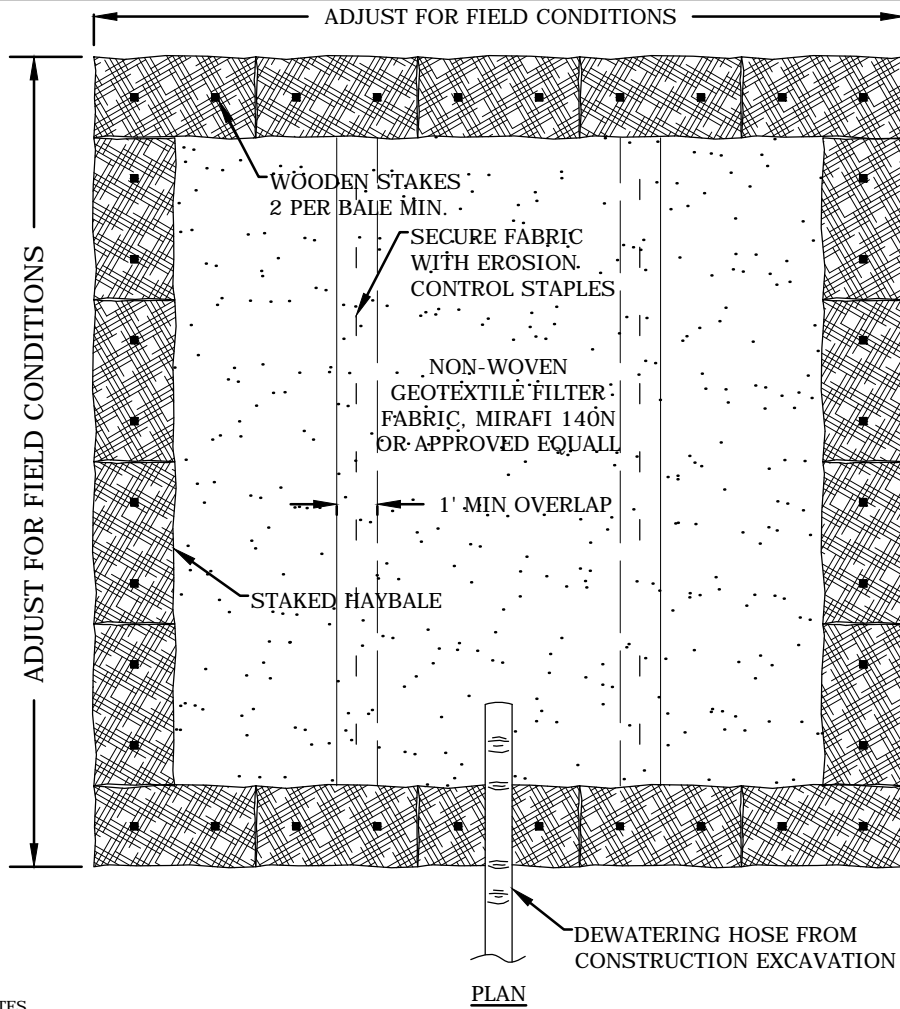

NOTES

1. SIZE OF BASIN AND ASSOCIATED NUMBER OF BALES MAY VARY BASED ON SITE CONDITIONS.
2. THE BASIN SHALL BE SIZED TO PREVENT DISCHARGE WATER FROM OVERTOPPING BASIN. IF BASIN IS OVERTOPPED DISCONTINUE USE IMMEDIATELY AND RE-SIZE.
3. KEEP BASIN AS FAR FROM WETLANDS AS PRACTICAL. DO NOT LOCATE BASIN WITHIN 25 FEET OF WETLANDS OR OTHER RESOURCES
4. BASINS SHALL BE LOCATED IN AREAS THAT ARE GENERALLY FLAT WITH SLOPES FROM 0-2%.
5. USE REINFORCED BASINS AS DETAILED WITH SILT FENCE AND STONE IN AREAS OF CONSIDERABLE FLOW AND FOR BASINS THAT ARE TO BE USED FOR PERIODS LONGER THAN 7 DAYS.
6. CLEAN AND REMOVE BASIN AS SOON AS DEWATERING IS COMPLETE.
7. CONCRETE JERSEY BARRIERS CAN BE SUBSTITUTED FOR HAYBALES AS DESIRED.

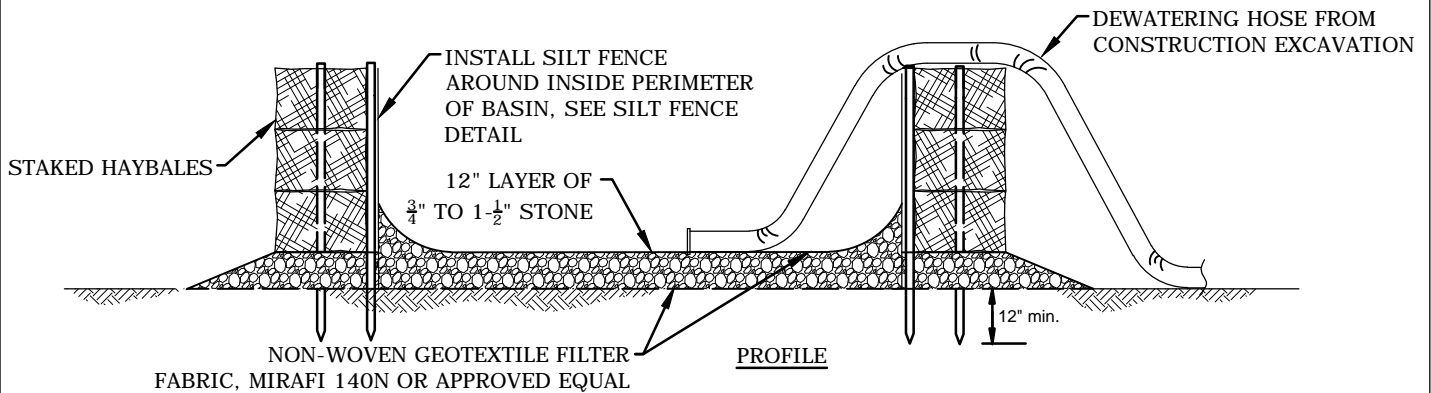

VERMONT ELECTRIC POWER COMPANY, INC.
366 PINNACLE RIDGE ROAD
RUTLAND, VERMONT 05701

REINFORCED DEWATERING BASIN - TYPICAL

DATE: 7/11/11

REV:

REF:

EC-13

VELCO ENVIRONMENTAL GUIDANCE MANUAL

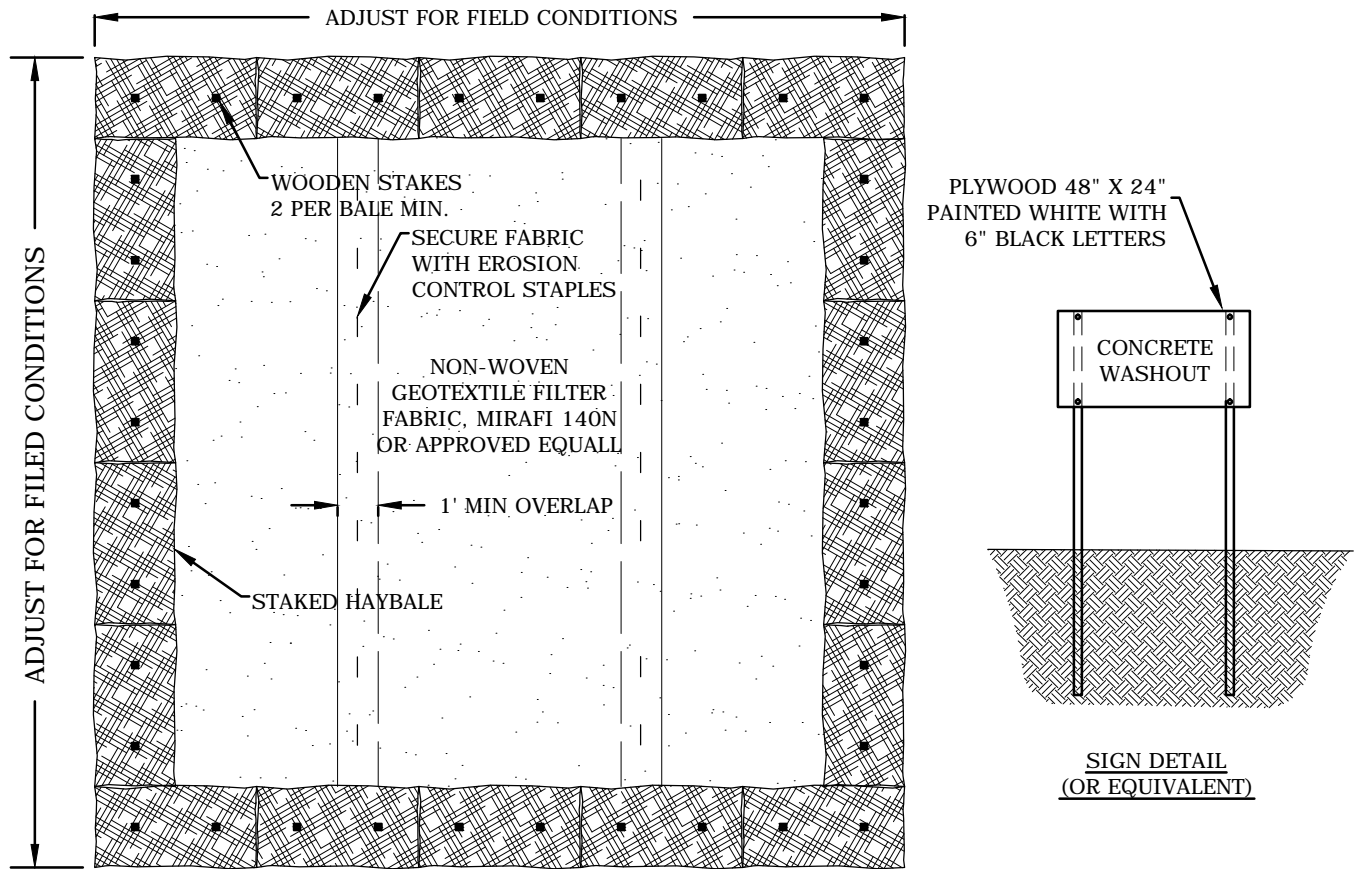

PLAN

NOTES:

1. SUMPS SHALL BE LOCATED AS FAR FROM WETLANDS AND DRAINAGE CHANNELS AS PRACTICAL.
2. SUMPS TO BE CLEANED AND WASTE CONCRETE REMOVED FOR PROPER DISPOSAL OF UPON COMPLETION OF WORK.

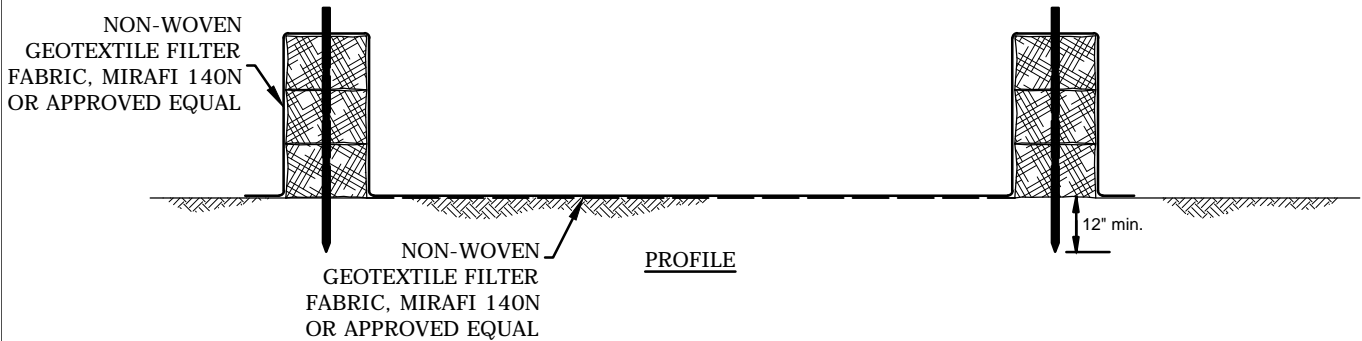

PROFILE



VERMONT ELECTRIC POWER COMPANY, INC.
366 PINNACLE RIDGE ROAD
RUTLAND, VERMONT 05701

CONCRETE WASTE SUMP TYPICAL

DATE: 7/11/11

REV:

REF:

EC-14

VELCO ENVIRONMENTAL GUIDANCE MANUAL

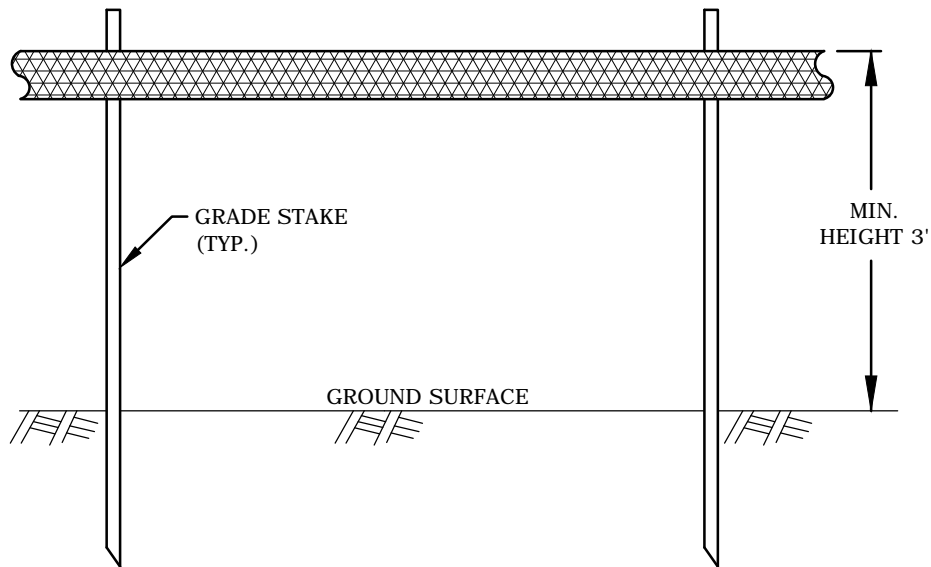

NOTES:

CONSTRUCTION FENCE OR SAFETY FENCE SHALL BE INSTALLED AROUND THE PERIMETER OF THE PROJECT TO DENOTE THE LIMIT OF DISTURBANCE. NO EARTHWORK OR STORAGE OF MATERIALS SHALL BE DONE OUTSIDE OF THIS LIMIT LINE.

FENCE MAY BE 4" ORANGE BARRIER FENCE OR 1/2" YELLOW POLYPROPYLENE ROPE.



VERMONT ELECTRIC POWER COMPANY, INC.
366 PINNACLE RIDGE ROAD
RUTLAND, VERMONT 05701

BARRIER FENCE TYPICAL

DATE: 7/11/11

REV:

REF:

EC-15

ATTACHMENT D

Recommended Seed Mixes

Temporary Seed Mix

| SEED | % WEIGHT |
|-----------------------|-----------------|
| Winter Rye | 80 min. |
| Red Fescue (creeping) | 4 min. |
| Perennial Rye Grass | 3 min. |
| Red Clover | 3 min. |
| Other Crop Grass | 0.5 max. |
| Noxious Weed Seed | 0.5 max. |
| Inert Matter | 1 max |

Notes:

- *Temporary seed mix shall meet the above criteria.
- * Temporary seed mix shall be used between 10/1 and 5/14.
- * Application Rate via broadcast seeding shall not be less than 25 lbs per acre

Permanent Seed Mix

| SEED | % WEIGHT |
|--------------|-----------------|
| Red Fescue | 50 |
| Sheep Fescue | 25 |
| Red Top | 5 |
| White Clover | 10 |
| Annual Rye | 10 |

Notes:

- *Permanent seed mix shall meet the above criteria.
- * Permanent seed mix shall be used as early as possible, between 05/15 and 9/30.
- *Application Rate via broadcast seeding shall not be less than 25 lbs per acre

Wetland Seed Mix

| SEED | % WEIGHT |
|------------------------|----------|
| Nodding Bur Marigold | 3 |
| Fox Sedge | 13 |
| Creeping Bentgrass | 14 |
| Riverbank Wild Rye | 8 |
| Virginia Wild Rye | 14 |
| Soft rush | 2 |
| Sensitive Fem | 1.5 |
| Blue Vervain | 1 |
| Blackwell Switch Grass | 25 |
| Grey Dogwood | .5 |
| Creeping Red Fescue | 18 |

Notes:

*Wetland seed mix shall meet the above criteria.

* Use in all wetland areas.

*Application Rate via broadcast seeding shall not be less than 18 lbs per acre

Wildlife Seed Mix

| SEED | % WEIGHT |
|-----------------------|----------|
| Climax Timothy | 39.8 |
| Potomac Orchard Grass | 28.5 |
| Medium Red Clover | 19.9 |
| White Clover | 9.8 |
| Inert Matter | 1.85 |
| Other Crop Seed | 0.1 |
| Weed Seed | 0.05 |

Notes:

*Wildlife seed mix shall meet the above criteria.

*Application Rate via broadcast seeding shall not be less than 25 lbs per acre

* Wildlife seed mix shall not be used in areas containing the following:

- Highly erodible soils.
- Within 50 feet of wetlands or streams
- Slopes greater than 2:1

ATTACHMENT E

Relevant BMP's

- E-1 Stream Crossing Guidance**
- E-2 Bat BMP's**

Vermont Electric Power Company

Stream Crossing Guidance



Prepared By:

VELCO Environmental Team

Rev. 0

April 2012

Table of Contents

| | |
|--|-----------|
| Introduction..... | 1 |
| Contact Information | 1 |
| Overview | 1 |
| Stream Assessments | 2 |
| Aquatic Organism Passage..... | 4 |
| Riparian Buffers..... | 5 |
| Types of Stream Crossing Structure | 5 |
| Mat bridges..... | 6 |
| Culverts..... | 7 |
| At-grade fords | 7 |
| Brush matting..... | 8 |
| Prefabricated bridges | 8 |
| Ice bridges..... | 8 |
| Erosion Prevention and Sediment Control..... | 9 |
| Restoration..... | 10 |
| Relevant Regulations and Recommended Practices | 12 |
| Department of the Army General Permit State of Vermont..... | 12 |
| Vermont 401 Water Quality Certificate (as written in the UASCE Vermont GP)..... | 13 |
| Vermont Agency of Natural Resources..... | 14 |
| Vermont Department of Environmental Conservation..... | 14 |
| Stream Alteration General Permit | 14 |
| Vermont Section 248 and Act 250 Criteria..... | 18 |
| Vermont Water Quality Standards | 19 |
| Vermont Statutes Title 10: Conservation and Development..... | 21 |
| Vermont Statutes Title 10: Conservation and Development..... | 22 |
| Recommended stream crossing references and other documents:..... | 23 |
| References | 24 |
| Appendices: | 25 |
| Typical Stream Crossing Details | 25 |

Introduction

Vermont Electric Power Company (VELCO) is a high voltage electrical transmission company. VELCO is responsible for the construction, operation and maintenance of its electrical transmission facilities throughout Vermont. Due to the linear nature, remote locations and access constraints, numerous environmental resources are often encountered, which must be traversed by construction and maintenance equipment. Streams are one of the most common features encountered. Therefore, this document is intended to provide guidance for VELCO representatives (including employees, consultants and contractors) in the planning, constructing, and utilization of the most appropriate stream crossing methods for equipment/vehicular access to new and existing VELCO facilities.

Contact Information

Any questions associated with VELCO or VT Transco facilities related to streams, stream crossing structures, or this document should be directed to:

Tim Follensbee
VELCO Environmental Team
366 Pinnacle Ridge Road
Rutland, VT 05701
(802) 770-6423

Overview

The term “Stream” has many definitions as described in technical papers, regulatory documents, guidance documents and throughout literature. The United States Army Corp of Engineers (USACE) and the VT Agency of Natural Resources (ANR) provide the same general definition of the term “stream” in the USACE Ecosystem Management & Restoration Research Program (EMRRP) glossary and in the ANR Vermont Stream Geomorphic Assessment (VSGA) Handbooks, Appendix Q Glossary of Terms. Where they both define the term stream as:

Stream -- A general term for a body of water flowing by gravity; natural watercourse containing water at least part of the year. In hydrology, the term is generally applied to the water flowing in a natural narrow channel as distinct from a canal.

The ANR more specifically defines the term “stream” in the document, Guidance For Agency Act 250 and Section 248 Comments Regarding Riparian Buffers (dated December 9, 2005), as:

Stream -- The full length and width, including the bed and banks, of any watercourse, including, but not limited to, bodies named creek, brook, river, branch or kill. A stream has a channel that periodically or continuously contains moving water, has a defined bed, and has banks that serve to confine water at low to moderate flows. Streams include intermittent streams that have a defined channel and evidence of sediment transport, even if such streams does not have surface water flow throughout the year and/or throughout the channel. For the purpose of this guidance,

constructed drainage ways including water bars, swales, and roadside ditches, are not considered streams.

Other relevant definitions from the USACE EMRRP glossary and the ANR VSGA glossary are;

Stream Channel -- A long narrow depression shaped by the concentrated flow of a stream and covered continuously or periodically by water.

Channel -- An area that contains continuously or periodically flowing water that is confined by banks and a streambed.

Streambed -- (1) The unvegetated portion of a channel boundary below the baseflow level. (2) The channel through which a natural stream of water runs or used to run, as a dry streambed.

Stream banks – features that define the channel sides and contain stream flow within the channel; this is the portion of the channel bank that is between the toe of the bank slope and the bankfull elevation. The banks are distinct from the stream bed, which is normally wetted and provides a substrate that supports aquatic organisms.

As part of the development of this document, the VELCO Environmental Team has reviewed these and numerous other definitions from a number of different agencies and respectable sources and has developed the following description that provides a thorough, comprehensive and accurate description of the necessary physical characteristics that must be present to qualify a feature as a stream and thus make it subject to this guidance document and applicable state and federal regulations.

A watercourse that flows water by gravity for at least a portion of the year, through a natural channel created from concentrated flow, containing a clearly identifiable streambed and banks, where the streambed is unvegetated due to regular inundation and the bank slopes confine normal flows of the active channel.

Stream Assessments

Once a feature is determined to be a stream, there are a number of characteristics that need to be identified in order to design and select the appropriate stream crossing methodology, as well as to ensure compliance with state and federal regulations.

The first characteristic that should be evaluated is the elevation of the stream during the regular bankfull discharge of the stream at the crossing location. The bankfull discharge is generally described as the regular high water event, which occurs on average every 1.5 years. The elevation of the water during the bankfull discharge is referred to as the **bankfull elevation**, which is generally synonymous with the US USACE's use of "ordinary high water" (or OHW) and in some instances can also be synonymous with the Top of Bank elevation. Determining the bankfull elevation requires either historical data in a specific location of a well studied stream or by performing an evaluation of the stream at the specific location of the crossing. Any person assessing the stream and determining the bankfull elevation should have sufficient education and/or experience to perform such an evaluation and make such a determination.

Once the bankfull elevation is determined on both sides of the stream at a specific location, these two locations should be marked and measured in a straight line perpendicular to the flow of the stream. This measurement yields the **bankfull width** of the stream at the crossing location. Accurately assessing the bankfull elevation and width of the stream at the location of the crossing is crucial to evaluating, designing and constructing a safe, effective and environmentally sound stream crossing structure. Although, there are a number of other factors that should also be assessed, the aforementioned variables are the two most important pieces of information that will need to be collected. Without accurate bankfull elevations and widths, the stream crossing structures would be highly susceptible to washing out. In addition, the crossing structure could constrict and create unstable and erosive banks.

The next physical characteristic that must be determined is the Top of Bank and/or the Top of Slope. The Top of Bank and Top of Slope are defined by the VT Agency of Natural Resources in the Riparian Buffers and Corridors Technical Papers as:

Top of Bank -- The point along the stream bank where an abrupt change in slope is evident, and where the stream is generally able to overflow the banks and enter the adjacent floodplain during flows at or exceeding the average annual high water stage.

Top of Slope -- A break in slopes adjacent to steep-banked streams that have little or no floodplain; or a break in slope where the side slopes adjacent to an incised, or deeply cut, channel meet floodplains that have been abandoned or are undergoing abandonment.

The Top of Bank and Top of Slope identifications are imperative, as most temporary crossing must be at or above the Top of Bank elevation depending on the type of stream crossing structure. Additionally, most regulatory agencies typically extend jurisdiction for fills or structures that are placed within the Top of Banks and/or Bankfull Elevation (OHW). This is especially important for temporary crossing associated with maintenance or other limited work activity. Additionally, the Top of Banks/Top of Slopes are generally associated with a less saturated and more stable soils in which to build a stream crossing structure from (or to be integrated with based on the type of structure). Therefore, accurate identifications of the Top of Banks/Top of Slopes are critical in the design and construction of the appropriate stream crossing structure.

Another key factor to identify while performing the stream assessment is to determine the type of stream that will be crossed. There are three types of streams; ephemeral, intermittent, and perennial. All three types of streams are encountered on VELCO ROW's and facilities. In addition, many of VELCO's transmission line corridors cross much larger streams including many of Vermont's largest rivers, generally these larger watercourses are impractical to cross with construction equipment using the crossing techniques contained herein. If the crossing of larger rivers with construction equipment is needed, special project-specific crossing methodologies will be developed. Ephemeral, intermittent and perennial streams, as defined by the ANR VSGA glossary are outlined below.

Perennial Stream -- One which flows continuously.

Intermittent stream -- Any nonpermanent flowing drainage feature having a definable channel and evidence of scour or deposition. This includes what are sometimes referred to as ephemeral streams if they meet these two criteria.

Ephemeral Stream -- One that flows only in direct response to precipitation, and whose channel is at all times above the water table.

Identifying whether a stream is perennial, intermittent or ephemeral in conjunction with other physical stream and watershed characteristics will illustrate the overall stability of stream, which may limit the type and configuration of the stream crossing structure. Ephemeral and intermittent streams may allow for limited crossing structures based on the time of year, magnitude of the work to be performed and the type/size of the equipment required to traverse the stream.

Additionally, identifying the location of the stream's thalweg, in relation to the stream crossing location, is important to understand how the flow and force of the stream is directed and could affect the stream crossing structure. The glossary of "Guidelines for the Design of Stream/Road Crossings for Passage of Aquatic Organisms in Vermont" defines the thalweg as:

Thalweg -- The longitudinal line connecting the deepest points in a stream.

The ANR VSGA glossary further defines it is as:

Thalweg -- (1) The lowest thread along the axial part of a valley or stream channel.
(2) A subsurface, groundwater stream percolating beneath and in the general direction of a surface stream course or valley.
(3) The middle, chief, or deepest part of a navigable channel or waterway.

For the purposes of this document the term **thalweg** shall be understood as:

The longitudinal line connecting the deepest points of the stream, where forces and flow velocity of the stream are the greatest.

Wherever possible, stream crossing structures should be designed so that the thalweg of the stream is centered through or beneath the center of the stream crossing structure. Stream crossing structures should avoid realignment, constriction, diversion, and/or alteration of the stream's thalweg. Significant alteration of the stream's thalweg without proper analysis and planning could have significant impacts to the physical and biological characteristics of the stream.

An additional piece of data that should be collected at each stream crossing location is the size of the drainage area of the stream at the crossing location. This is an important piece of data as it provides a key piece of information needed when designing the size, shape, and alignment of the crossing, as well as, it is a key indicator of whether or not the crossing structure will require agency authorization. This effort is typically performed utilizing existing topographic and watershed data. There are a number of ways to calculate the drainage area of a certain location and many methods are acceptable.

Aquatic Organism Passage

Aquatic organism passage is a large concern associated with stream crossing structures. This is due to many inadequately designed or constructed stream crossing structures which have led to the fragmentation of aquatic habitats. Therefore, stream crossing structures should be designed and constructed so that they do not impede aquatic organism passage beyond the actual duration of construction. As such, it is important to identify whether a stream is perennial, intermittent, or ephemeral, as the type of stream is a significant indicator of whether it supports aquatic organisms and may also indicate potentially beneficial construction timeframes when the stream is not realizing flow.

The presence of aquatic organisms (e.g. macroinvertebrates, amphibians, and cold and warm water fish species) is an important consideration when designing stream crossing structures. If it is determined that the stream does support aquatic organisms, the stream crossing structure should be designed to provide adequate passage of such organisms. Stream crossings structures installed in streams supporting aquatic organisms should be installed in such a way as to allow for the native aquatic organisms to pass freely both upstream and downstream with minimal impact on the substrate. One way this can be accomplished is to ensure that the streams physical characteristics upstream, beneath the stream crossing structure, and downstream remain consistent without substantial changes that might inhibit aquatic organism passage. Aquatic organism passage is less of a concern when considering the design of temporary crossing structures, provided the stream crossing structure would not substantially hinder aquatic organism passage during important migration periods of such organisms. Scenarios such as this will need to be reviewed and approved on a case by case basis by a member of the VELCO Environmental Team.

Riparian Buffers

Protection and minimization of the impacts to **riparian buffers** is another important consideration in the design and installation of stream crossing structures. The ANR's definitions of riparian buffers in the Riparian Buffers and Corridors Technical Papers and VSGA Appendix Q are essentially the same. The definition in the Riparian Buffers and Corridors Technical Papers is described as:

Riparian Buffer Zone – The width of land adjacent to lakes or streams between the top of the bank or top of slope or mean water level and the edge of other land uses. Riparian buffer zones are typically undisturbed areas, consisting of trees, shrubs, ground cover plants, duff layer, and naturally vegetated uneven ground surface, that protect the waterbody and the adjacent riparian corridor ecosystem from the impact of these land uses.

Riparian buffers can provide a number of functions and values to the stream and associated ecosystem. They can protect water quality and aquatic habitats, provide terrestrial habitats, act as travel and dispersal corridors for terrestrial wildlife, support certain significant natural communities and adjacent wetlands, and protect channel forming processes and channel stability. Due to the significance of many functions and values associated with certain riparian buffers and given the fact that each stream and associated riparian buffer is different and may vary at each crossing location, it is important to assess the functions and values the riparian buffers provide in the vicinity of the proposed crossing location. Next it is important to evaluate the impacts associated with each potential type of stream crossing structure and approach roads at each potential crossing location. All feasible stream crossing structure configurations should be evaluated, and the selected type designed, aligned, constructed, utilized, removed (if temporary) and restored (if removed) in a manner that minimizes impacts to riparian buffers to the extent possible.

Types of Stream Crossing Structure

Due to the topography of Vermont, the majority of streams encountered on VELCO right-of-ways are first and second order ephemeral and intermittent streams. Although, many VELCO corridors cross many large streams and rivers, most of the larger streams or rivers encountered can be avoided by construction equipment, as they are generally impractical to cross for the purposes of VELCO activities. However, it is important to note that certain situations may require crossing of large streams, but these situations will be avoided whenever possible. As such, this plan is intended to focus on the most typical type of streams that will be encountered. The assumption is that small through mid size streams may require stream crossing structures and larger streams and rivers will be avoided, if possible. If avoidance of larger streams and rivers is not practical a separate and more thorough data collection, engineering, design, and permitting effort may be required.

There are two types of stream crossings, temporary crossings and permanent crossing. It is important to establish whether a crossing will be a temporary or permanent crossing as early in the process as possible, since all other aspects of the design will be based on this information. There are several types of structures that can be utilized to cross streams, the two of which that are most common are bridges and culverts. However, the terms “bridge” and “culvert” are very general terms as there are a number of different types, designs, and standards of each. This document identifies the most commonly utilized and the least environmentally damaging options available.

It is important that stream crossing structures be adequately designed and constructed to avoid restricting flow during regular high water events, to withstand the forces of regular high water events, to maintain existing low flows, maintain the streams ability for natural sediment transport, and to not obstruct the movement or passage of aquatic organisms. To the extent possible stream crossing structures should be located on straight stretches of stream, perpendicular to the flow, and where the stream’s thalweg is generally located in the middle of the stream channel. Additionally, all stream crossing structures should be designed to avoid stream channel realignment and to minimize impacts to the stream channel and banks. If it is necessary to realign a stream channel or perform any significant amount of work within the top of banks of the stream or on the approaches to the stream in order to install a specific crossing structure, then VELCO Environmental personnel must review and approve the proposed design prior initiating any such work.

The majority of stream crossing structures required for VELCO activities are temporary structures. Furthermore, the structures that are installed on a permanent basis are utilized for a limited duration or utilized infrequently by specialized equipment (generally tracked or low ground pressure equipment). As such, stream crossing structures required for VELCO activities, although sharing some of the same requirements as other types of structures, may differ greatly. Below is a description of typical stream crossing structures utilized in transmission line construction and maintenance.

Mat bridges are very common for temporary stream crossings and are the most common stream crossing structure utilized on VELCO projects. Mat bridges can be constructed in a number of different ways, which make them very versatile where variable field conditions exist, compared to other crossing structures. When constructing mat bridges it is important from safety and environmental aspects to ensure that all mats utilized are in good condition and can support the weight of the equipment. Although typically constructed with the use of heavy duty timber mats, other laminated or flat mats may be utilized on the top layer to reinforce the bridge span and to catch sediment tracked on to the bridge; however these types of mats may not be load bearing. Mat bridges should span from top of bank to top of bank or at a minimum span 1.2 times the bankfull width at the crossing location. Mat bridges should also have one stream bank abutment mat on each side to protect the integrity of the stream banks (see attached detail for more information). Whenever possible, mat bridge abutments should be set back away from the top of bank. This displaces pressure away from the stream banks instead of directly down onto them, preventing bank failure and potential sediment discharge to the stream, as well as, providing increased structural stability to the bridge. Timber mats can be ordered in a number of different sizes, typical sizes range from 8 to 12 inches thick, by 4 feet wide, by 16, 18, 24, or 40 feet long. In some instances it may be necessary to provide structural support to the bridge, by placing additional mats in the stream beneath the span. This activity must be approved by VELCO Environmental prior to installation. If mat bridges are utilized to cross perennial streams, they should span a minimum of 1.2 times the bankfull width of the stream at the stream bed elevation and be elevated to Q25 headwater depth plus 1 foot above the lowest point of the bridge. Please refer to the mat bridge details provided in appendix 1.

Culverts are another very common stream crossing structure. Although, culverts are sometimes used as a temporary crossing structure due to safety or specialized equipment access, they are more commonly installed as permanent stream crossing structures. When designed and installed correctly, culverts can be very effective stream crossing structures, which can last for many years. However, when designed or installed incorrectly, they can lead to numerous physical and biological stream impacts. Improperly designed or installed culverts can lead to culvert failures, stream incision, aggradation and degradation, streambed and bank erosion, channel instability, and the degradation of aquatic organism habitat. There are numerous sizes and types of culverts, all of which serve to provide different functions. Types of culverts include: HDPE circular smooth and corrugated culverts, steel circular smooth and corrugated culverts, steel corrugated squash culverts, bottomless arch culverts, circular smooth concrete culverts, and box culverts. Each type of culvert is designed to perform differently and to be utilized in certain circumstances.

Culverts must be sized accordingly to accept the peak flow volumes, which are typically based on the 25 year precipitation event for permanent culverts. However, there are many other physical characteristics that must be considered in the design of the culvert; failure to incorporate all necessary criteria can have detrimental effects. Improperly designed or constructed culverts can be a significant obstacle for aquatic organism passage. Therefore, aquatic organism passage should be one of the primary focuses when designing culvert crossings. Bottomless box and arch culverts typically do not create as many obstacles to aquatic organism passage as other types of culverts with bottoms or circular culverts. Circular culverts and culverts with bottoms should be embedded approximately 20 to 40 percent, culverts should be as wide if not wider than the bankfull width, native substrate or similar material should be spread throughout the culvert, outlets should not be perched, the slope of the culvert should match the slope of the stream, and the water depth within the culvert should be roughly the same as within the stream, both upstream and downstream.

Once the installation of the culvert is complete the streambed and substrate upstream, within, and downstream of the culvert should be indistinguishable from each other. Failure to incorporate these considerations into the culvert design and installation could have impacts on aquatic organisms. Improperly designed or installed culverts can have both physical and biological environmental impacts to the waterway. As such, it is important that culverts be sized by a qualified individual and actual culvert designs include the considerations described above, as well as, further considerations as described in *Guidelines for the Design of Stream/Road Crossings for Passage of Aquatic Organisms in Vermont*. If culverts are utilized to cross perennial streams, they should span a minimum of 1.2 times the bankfull width of the stream at the stream bed elevation and have a Q25 headwater depth plus 1 foot above the inlet opening of the culvert. Please refer to the culvert details provided in appendix 1.

At-grade fords may be utilized for both temporary and permanent stream crossings. Fords are generally not a preferred stream crossing method, but in certain situations they can be utilized in an effective and environmentally sound manner. Fording streams should only be undertaken at existing ford locations or under appropriate conditions. When determining whether fording a stream is appropriate or not, there are a several items that should be considered. Specifically, the approaches to and from the stream should be relatively flat and the stream substrate and approaches should be comprised of stable material. The type of equipment that will be utilizing the ford, the number of anticipated passes, and whether environmental impacts are likely to occur as a result of the utilization are several considerations that should be evaluated prior to use. If it is determined that the ford may be utilized, all equipment should be cleaned and inspected before the ford may be utilized. Equipment should be free of observable soil and vegetation, as well as, petroleum or other hazardous products including, but not limited to, gasoline, engine oil, hydraulic oil, grease (including excess grease around fittings), diesel fuel, anti-freeze, etc.

Brush matting is generally not a preferred stream crossing method. However, similar to stream fords, temporary brush crossings utilized under certain conditions may be the most effective stream crossing method available. Brush matting should only be utilized under frozen ground conditions and streams generally less than 6 feet wide. Additionally, streams should have minimal flowing water at the time of crossing, the crossing must only be needed for limited access, and the brush should be at least 6 inches in diameter and placed in such a way as to protect the streambed and banks. Upon completion of use, all material must be removed from the stream, and at no time should the material hinder, block or divert flow within the stream channel.

Prefabricated bridges are sometimes utilized in construction projects. They are temporary structures, which are generally made from steel and are often longer and stronger than most temporary bridges constructed onsite from wooden mats. However, they have several significant disadvantages. First, although they are longer and stronger they are also much heavier and cumbersome to move and install. Second, since the majority of the locations where VELCO requires stream crossing structures are in remote locations with limited access, the utilization of these types of structures is generally impractical. Lastly, they are expensive and require large and heavy, machines for transport and installation. If prefabricated bridges are utilized to cross perennial streams, they should span a minimum of 1.2 times the bankfull width of the stream at the stream bed elevation and be elevated to Q25 headwater depth plus 1 foot above the lowest point of the bridge.

Ice bridges are not practical for general everyday stream crossings, however in certain situations they can be extremely effective, cost efficient and environmentally preferable. Ice bridges can be effective stream crossing structures in situations where large streams or rivers must be crossed to reach isolated structures that have no other access, such as on islands or topographically constrained areas. There are a lot of factors to consider regarding the construction of an ice bridge, such as the duration the crossing is needed, the type of equipment that will need to utilize the crossing, and the time of year the crossing will be needed. Ice bridges are temporary crossing structures, which are seasonally and temperature dependent, and must be reviewed and approved by VELCO Environmental and/or regulatory agencies prior to installation. When constructed properly, ice bridges can save a lot of in stream work such as, water diversion, dam and pump efforts, impacts to stream banks for approaches, installation and removal of alternative bridge materials, and restoration work. Additional advantages include limited planning and engineering efforts, potentially less environmental impacts and associated permitting issues.

Construction of an ice bridge is fairly straight forward, however the actual bridge dimensions and thickness should be provided by an engineer. Generally an ice bridge will be constructed approximately 30 feet wide and will require 24+ inches of ice thickness. Once the exact details of the bridge have been established by an engineer, they may need to be provided to the regulatory agencies for review and/or authorization prior to commencement of work.

In order to construct a suitable ice bridge the stream must be frozen enough to support foot traffic and small hand held equipment, such as a generator and pump, and must have flowing water deep enough to pump from throughout the construction process. Once these preliminary requirements have been met, crews should complete a safety briefing and initiate work. First, sidewall retaining structures are necessary to allow ice to build up within them in order to make a flat driving surface, so that equipment does not slide off the ice bridge in either direction. This can be accomplished by lining up straw bales end to end from one bank to the other on both the upstream side and the downstream side at the appropriate width of the ice bridge.

With the straw bales in place and tightly pushed together, the next step is to start spraying or pumping water. This is generally accomplished by augering a hole through the ice on the outside of the straw bales on either the upstream or downstream side, in the middle of the stream. Then the suction end of the pump can be submerged in the water and start pumping water between the straw bales. All generators and/or pumps, should be placed in a solid plastic container as secondary containment to ensure the oil, fuel, etc is not released on the ice or into the stream. All additional fuel, oil, etc must be stored in an upland location away from the stream where accidental releases will not reach the stream or other protected resources (please see the Spill Response Procedure sections of VELCO's Environmental Guidance Manual in the event of any release of hazardous material). Once crews start to pump water into the bridge area, it is imperative to spray down the straw bales and saturate them. Once they are saturated, they will freeze and form a seal allowing water to build up within the straw bales and start to form the ice bridge. It is likely that the straw bales will have to be saturated numerous times, before they will freeze solid enough to retain the majority of the water on the bridge.

Once the bales will hold water, crews can pump water between the bales allowing ice to form until the ice is the appropriate thickness and quality as specified by the engineers. It will be necessary to cut the baling twine on the straw bales, after they are frozen, but before they are buried in ice. This will allow the bales to slow dissipate downstream with the thawing ice, versus creating a potential build up or temporary damming in the stream. When pumping water on the ice bridge it is better to pump smaller lesser volumes of water and to not spray the water as much as possible. Otherwise numerous air bubbles are captured within the freezing water leading to weaker ice. It is important to have solid ice, free of air bubbles to improve the strength of the ice bridge. An effort of this nature will likely take a few days to complete, however this is highly dependent of the temperature at the time of the efforts. Temperatures below 15 degrees F are preferable.

Erosion Prevention and Sediment Control

Discharges of turbid water to streams and other aquatic resources can have significant impacts on both the physical and biological characteristics of the resource. Sediment discharges can impact aquatic organisms, fill in floodplain areas, alter stream substrate material, hinder aquatic organism passage, contribute to aggradation or degradation of the stream, and contribute to water pollution. Therefore, efforts should be taken to limit erosion in the vicinity of the stream crossing and prevent the discharge of sediment laden (turbid) water to the stream or any other aquatic resource.

There can be numerous difficulties related to standard erosion prevention and sediment control measures at stream crossing locations, especially in mountainous terrain. For instance, the approaches to the stream crossing structure generally descend a hill until they reach the stream crossing. If the approaches are used on a regular basis, they are typically void of any substantial vegetation and many times develop ruts leading down to the stream. The lack of vegetation allows stormwater or shallow groundwater which has surfaced, to flow freely across the ground surface without disruption, hence increasing flow velocities, allowing for soil suspension and movement and eventually leading to rill or gully erosion. The development of wheel or track ruts created by passing machinery can act as small artificial channels that collect stormwater and ground water and channel turbid water down the approaches to the stream. This type of situation is very common and sometimes difficult to control if not properly planned for in advance.

Water source control is the best practice to control erosion along access routes, as fixed erosion control measures are typically not as effective. Waterbars are an effective means of water source control; however the waterbars must be maintained on a regular basis and/or reinforced with suitable material. Additionally, the water diverted from the access route by the waterbars must have an appropriate discharge location. Appropriate discharge locations will vary depending on the specific characteristics of

each site, but some options include; discharging to an upland location that is adequately vegetated or reinforced with stone to provide sufficient treatment prior to the water reaching the stream or discharging to an adequately constructed ditch, if present. Ditches are typically constructed on the uphill side of the road and must be adequately stabilized (e.g. vegetation, erosion control blankets, rock lined) and provide sufficient water treatment (e.g. rock check dams, rock lining, etc.) prior to any discharge water reaching the stream.

A complicating issue at some stream crossing locations may include the potential instability of soils of the adjacent access route and approaches leading to the stream crossing structure. If the access route consists of unstable material it will lead to the rutting issues described above, as well as discharges that lead directly to the stream. Second, when the access routes material becomes saturated and unstable it may lead to the tracking of sediment onto the surface of the stream crossing structure. If this deposited sediment is left on the stream crossing structures to accumulate it may lead to sediment discharges to the stream, either by falling through holes in the structure into the stream, by traffic displacing the material over the sides of the stream crossing structure into the stream, or by being washed off the structure into the stream by stormwater.

There are several ways sediment discharges can be either avoided or minimized. First, minimize utilizing the access routes during wet/saturated conditions. If it is observed that rutting and/or tracking of sediment from the access road is occurring, discontinue use of the crossing until conditions improve. Second, stabilize the access roads and approaches to the stream crossing with appropriate material, as needed. Pervious material is preferred; this typically consists of larger size (2-3 inch) angular rock, with less than 10 percent fines. Third, in many cases it can be very helpful to utilize construction mats to stabilize the approaches and the crossing structure (such as culverts that are not already constructed of mats). This allows soil and sediment to be dispersed on the mats prior to reaching the stream crossing, it also maintains the integrity of the soil beneath the mats, and does not allow additional accumulation of sediment on to the passing equipment. Fourth, clean the stream crossing structures of soil and sediment accumulation at the end of each day, before each precipitation event, or as needed throughout the work day. Routine cleaning of the bridge is easily accomplished on structures that are either constructed of or have been stabilized with construction mats. Generally, a small excavator can clean the majority of the soil and hand tools, such as flat shovels and brooms can be used to remove the remaining soil and debris. Lastly, stream crossing structures that are anticipated to be utilized during less than optimal weather conditions where tracking of sediment or other accumulation of sediment is expected on the stream crossing structure, the crossing should be constructed with a raised containing structure on both sides of the crossing structure. This would include structures such as headwalls on culverts and curbing on bridges.

Although fixed erosion controls have certain limitations in many stream crossing situations, they can be very effective when utilized adjacent to the access roads in protecting the stream from discharges. See detail drawings for more information. If a turbid discharge to a stream is identified, corrective actions to stop the discharge and VELCO Environmental personnel should be contacted as soon as reasonably possible.

Restoration

The amount of restoration required at each stream crossing location is dependent on the particular site. For instance, a permanent stream crossing location will likely not require as much restoration effort as a temporary crossing would. Similarly, as a stream crossing in a relatively flat area would likely not require as much restoration efforts as one located in steep terrain.

Permanent stream crossings should be routinely inspected to ensure that they continue to remain in safe working condition, as well as, to ensure that they are not degrading and/or causing environmental impacts to the stream or surrounding environment. Upon completion of the installation efforts, any disturbed area surrounding the site should be seeded and stabilized. Every effort should be made to achieve permanent stabilization surrounding the site as soon as reasonably possible to safeguard against potential discharges and potential impacts associated with unanticipated flood events. Access routes should also be stabilized, as described above in the erosion prevention and sediment control section and in accordance with the VELCO Environmental Guidance Manual.

Temporary crossings typically require more restoration work than permanent crossings at the time of removal, however once removed and restored, they no longer require ongoing inspections. When removing temporary crossing structures, it is important to completely remove all material that was part of the crossing structure. Care should be taken at all times during installation, removal and restoration, to protect the streambed, banks and surrounding vegetation. If the stream banks or floodplain have been altered from the installation or removal of the crossing structure, they should be restored to their approximate preconstruction elevations and should match/blend with both the upstream and downstream banks and floodplain. Once this is complete, the area should be appropriately seeded and stabilized. As with the permanent crossing, it is important to achieve permanent stabilization as soon as possible. In some situations it may be desirable or necessary to stabilize slopes or banks with vegetation, such as compatible shrubs or other woody plants. This type of planting may be warranted if bank or slope stabilization is primarily dependent on root masses binding soils together to prevent erosion and where routine access is not expected. This is typically encountered in streams where higher flow velocities are encountered, subjecting the banks to stronger erosive forces. In most of these situations this type of stabilization can be accomplished by "Live Staking" of woody species. Please refer to The Vermont Standards and Specifications for Erosion Prevention and Sediment Control Part 4 (Standards and Specifications for Erosion Control) at page 4.51 for more details. All seed and Live Stake plantings should be native species to Vermont and compatible with of the area and habitat where they are being planted.

Relevant Regulations and Recommended Practices

The following regulations and recommended practices are relevant parts of each regulation and are not intended as a comprehensive summary of the actual statutes, permit requirements, regulations, guidance or recommended practices. For a more thorough understanding of each, please ensure that you have read and completely understand the entire document associated with each of the following relevant sections.

Department of the Army General Permit State of Vermont Section V. General Conditions

21. Waterway/Wetland Work and Crossings

(a) All temporary and permanent crossings of waterbodies shall be suitably culverted, bridged, or otherwise designed to withstand and to prevent the restriction of high flows, to maintain existing low flows, and to not obstruct the movement of aquatic life indigenous to the waterbody beyond the actual duration of construction.

(b) No activity may substantially disrupt the necessary life-cycle movements of those species of aquatic life indigenous to the waterbody, including those species that normally migrate through the area, unless the activity's primary purpose is to impound water.

(c) To meet the objective of aquatic organism passage in (a) and (b) above, all temporary and permanent crossings of rivers, streams, brooks, etc. (hereon referred to as "streams") shall meet the following performance standards in order to qualify for Category 1 (refer to Additional References on Page 18):

- i. Design the structure to maintain a streambed composition and form throughout the culvert similar to and continuous with the adjacent reaches. To do this:
 - o Design and install streambed material and bedforms if not adequately supplied and developed naturally,
 - o Design profile and alignment through structure similar to those of adjacent stream reaches,
 - o Design culvert elevation to remain embedded for the life of the structure and in consideration of future channel conditions.
- ii. Maintain velocities, turbulence and depths within the structure similar to those found in adjacent stream reaches across a range of desired flows.

(d) The requirements to comply with the performance standards in (c) above in order to proceed as a Category 1 project do not apply to the following:

- i. Temporary crossings in place for less than 90 days (the requirements in (a) do apply). Temporary culverts must be embedded unless they're installed during low flow (Jul. 15 – Oct. 1) and it's placed on geotextile fabric laid on the stream bed to ensure restoration to the original grade;
- ii. Constructed drainage systems designed primarily for the conveyance of storm water or irrigation.

Also, non-tidal drainage and irrigation ditches excavated on dry land are not Federally-regulated.

(e) Applicants proposing new crossings, or maintenance or replacement of serviceable crossings should refer to the Guidelines for the Design of Stream/Road Crossings for Passage of Aquatic Organisms in Vermont when the State finalizes these guidelines. Refer to Additional References on Page 18.

(f) Applicants shall use the least intrusive and environmentally damaging method to construct the stream crossing, following this sequential minimization process: bridge spans, open bottom arches or embedded culverts. Refer to Additional References, Page 18.

(g) Culverts at waterbody crossings shall be installed in such a manner as to preserve hydraulic connectivity, at its present level, between the wetlands on either side of the road. The permittee shall take necessary measures to correct wetland damage due to lack of hydraulic connectivity.

(h) Projects using retrofit methods increasing flow velocity or slip lining (retrofitting an existing culvert by inserting a smaller diameter pipe) are not allowed in Category 1, either as new or maintenance activities.

(i) No projects involving open trench excavation in flowing waters, except riprap installation, are allowed under Category 1. Open trench excavation projects may qualify for Category 1 provided (1) the work doesn't occur in flowing waters (requires using management techniques such as temporary flume pipes, culverts, cofferdams, etc.) and (2) normal flows are maintained within the stream boundary's confines (see Appendix A, Endnote 5). Projects utilizing these management techniques must meet the other Category 1 requirements (see Appendix A, Page 1) and all of this GP's terms and general conditions.

(j) For projects that otherwise meet the terms of Category 1, in-stream (e.g., rivers, streams, brooks, etc.) construction work shall be conducted only during the low flow period of July 15 to October 1 in any year. Projects that are conducted outside that time period are ineligible for Category 1 and shall be reviewed under Category 2, regardless of the waterway and wetland fill and/or impact area.

(k) Work impacting upstream or downstream flood profiles must be reviewed under Category 2.

General Information for GC 21:

For stream crossing projects, see Page 2, III(A)(i)(6) for VT ANR WQC Category 1 qualifications.

23. Floodplain Work.

(a) In order to qualify for authorization under Category 1 of this GP, projects shall result in no more than a minimal decrease in natural valley storage, and shall not result in an increase in the base flood elevation (where hydraulic information necessary to make this determination is available).

(b) There shall be no Category 1 projects located within a FEMA designated Special Flood Hazard Area as shown on the most current flood insurance studies and maps published by FEMA and adopted by the municipality within which the proposed project is located.

(c) Any project located within a FEMA designated Special Flood Hazard Area shall comply with minimum NFIP regulations, or local Flood Hazard Area regulations if more restrictive.

Vermont 401 Water Quality Certificate (as written in the UASCE Vermont GP)

Section III. Procedures:

A. State Approvals

Applicants are responsible for applying for and obtaining any of the required State approvals (see General Condition 1). Federal and State jurisdictions may differ in some instances. State permits may be required for specific projects regardless of the general permit category.

i. In order for authorizations under this GP to be valid, when any of the following state approvals or statutorily-required reviews is also required, the approvals must be obtained prior to the commencement of work in Corps jurisdiction.

(1) Vermont Agency of Natural Resources (VT ANR) approval of a Conditional Use Determination under the Vermont Wetland Rules;

(2) VT ANR approval of a Stream Alteration Permit under Title 10, Chapter 41, Subchapter 2;

(3) VT ANR approval of a Lake Encroachment Permit under Title 29, Chapter 11, Management of Lakes and Ponds;

(4) VT ANR approval of a Dam Construction Permit under Title 10, Chapter 43, Dams;

(5) Vermont Department of Fish and Wildlife (VT F&W) approval of a Stream Obstruction Permit under Title 10, Chapter 111, Section 4607.

(6) VT ANR, Water Quality Division, issuance of a Water Quality Certification (WQC) under Section 401 of the CWA (33 USC 1341). Section 401(a)(1) of the CWA requires applicants to obtain a WQC or waiver from the state water pollution control agency (VT ANR) to discharge dredged or fill materials into

waters of the U.S. The VT ANR has granted WQC for GP Category 1 activities provided that the applicant obtains the required approvals listed above and the project fully complies with all terms and conditions of this GP. The VT ANR reserves the authority to enforce any violation of the Vermont Water Quality Standards that results from any Category 1 activity. Therefore, a separate 401 WQC application is not required for activities involving fill in waters of the U.S. authorized under Category 1 of this GP. However, all stream crossings at locations with drainage areas of one square mile or greater that would otherwise qualify for Category 1 of the VT GP are granted a WQC subject to the following:

- The crossing is a temporary installation consistent with “Acceptable Management Practices for Maintaining Water Quality on Logging Jobs in Vermont,” or
- The crossing has received written approval from the VT ANR, or
- More than 21 calendar days elapse without a response from the date of receipt by the VT ANR of complete information describing the crossing location and design.

The VT ANR conditionally granted WQC for GP Category 2 activities listed in Appendix A of this GP provided (1) the applicant obtains the required approvals listed above and (2) the Corps notifies the VT ANR and the VT ANR finds that the activity is reasonably likely to have minimal or no impact on water quality. The VT ANR retains the right to require an Individual WQC for any Category 2 activity. The VT ANR will respond within the same response times required of the Federal resource agencies.

ii. The State of Vermont also requires project proponents to obtain the following authorizations from the State when applicable:

(7) VT ANR approval of a 1272 Order under Title 10, Chapter 47;

(8) VT National Flood Insurance Program (NFIP) confirmation that the proposed project is in compliance with the minimum NFIP regulations consistent with 24 VSA 4424.

(9) VT ANR approval of a threatened and endangered species permit, 10 VSA Chapter 123, administered by VT F&W.

Vermont Agency of Natural Resources Vermont Department of Environmental Conservation Stream Alteration General Permit (Sections C.2 through D)

Applicability: The subject of this General Permit is Stream Alterations which involve the fill or excavation of 10 cubic yards or more within the top-of-bank to top-of-bank, cross-sectional limits of perennial streams.

C.2. Activities Eligible for Coverage

C.2.1. Non-Reporting Activities – Unless specified otherwise in this general permit, activities listed in C.2.1.1 through C.2.1.9 below, that are conducted in accordance with the activity-specific requirements set forth in this general permit, and are not located in a designated Outstanding Resource Water, will meet the requirements of 10 VSA §1023(a) and may proceed without notification to the Secretary, regardless of watershed size (and as indicated in the Activities Table, page 11).

The Secretary may, upon review, determine an individual activity, that does not fall under the types of activities and compliance criteria listed in C.2.1.2 through C.2.1.9, to be a de minimus activity consistent with the requirements of 10 VSA §1023(a); which may then proceed as a Non-Reporting Activity.

10 VSA §1023(a) requires that an activity:

- (1) will not adversely affect the public safety by increasing flood hazards:

- (2) will not significantly damage fish life or wildlife;
- (3) will not significantly damage the rights of riparian owners; and
- (4) in the case of any waters designated by the board as outstanding resource waters, will not adversely affect the values sought to be protected by designation.

Non-Reporting Activities must be conducted in a manner which minimizes or avoids any discharge of sediment or other pollutants to surface waters in violation of the VT Water Quality Standards (Note: all reasonable means to avoid discharges must be taken during trout spawning periods before July 1 and after October 1).

- C.2.1.1. Activities other than those activities listed under C.2.1.2 through C.2.1.9. provided:
- a) The activity is conducted where the drainage area of the upstream watershed is less than 1.0 square miles; and
 - b) The activity is consistent with and supports the Equilibrium Standard.

C.2.1.2. Directionally bored utility crossings involving no earthwork within the watercourse.

C.2.1.3. Municipal dry hydrants provided the intake is installed within 50 linear feet of a municipal bridge or culvert.

- C.2.1.4. Repair or replacement of existing bridges provided:
- a) Scour protection or erosion treatments do not reduce the channel cross section dimensions and cross sectional area; and
 - b) There is no channel realignment; and
 - c) There is no roadway realignment ; and
 - d) The repaired or replacement structure provides a span length 1.2X bank full width² or greater at the streambed elevation; and
 - e) The repaired or replacement structure provides a Q25 headwater depth + one (1) foot that is no higher than the elevation of the lowest superstructure element; and
 - f) Any temporary structure for traffic maintenance during construction provides a span length 1.0X bank full width or greater.

C.2.1.5. New private temporary or permanent stream crossing structures of any type or replacement of existing culverts provided:

- a) The structure span length at the streambed elevation is no less than 1.2X bank full width; and
- b) The Q25 headwater depth+ one (1) foot is no higher than the elevation of the lowest superstructure element of a bridge or the top of the inlet opening of a buried structure; and
- c) The structure shall not obstruct the movement of aquatic life indigenous to the waterbody beyond the actual duration of construction. No activity may substantially disrupt the necessary life cycle movements of those species of aquatic life indigenous to the waterbody, including those species that normally migrate through the area. To meet this provision of the General Permit and to qualify as a Non-Reporting Activity, the project shall be designed, in consideration of current and future conditions, such that the stream will naturally and permanently retain, through the structure, the substrate composition, bedforms, vertical profile, horizontal alignment, and flow velocities, turbulence, and depth similar to adjacent stream reaches. Technical guidance for designing stream crossings for aquatic organism passage can be found at: http://www.vtfishandwildlife.com/fisheries_AOP.cfm; and
- d) Minimal earthwork is required to construct roadway approaches to the crossing; and

- e) Stream alignment at and upstream of the structure is relatively straight; and
- f) No significant stream bank erosion, streambed degradation or other indicators of active lateral or vertical adjustment of the channel is present; and
- g) If the proposed project is located in a Flood Hazard Area as designated in the municipal Flood Hazard Area regulations, prior to construction, a municipal zoning permit is obtained in compliance with such regulations.

C.2.1.6. Projects fully or partially funded through FEMA Public Assistance, Hazard Mitigation Assistance, USDA Emergency Watershed Protection, or Better Back Roads programs that have been technically reviewed and endorsed by the Secretary.

C.2.1.7. Fluvial geomorphic, channel, flood plain, and aquatic habitat restoration projects that have been technically reviewed and endorsed by the Secretary.

C.2.1.8. At-grade fords provided:

- a) The ford is properly stabilized with clean stone fill; and
- b) There is no change in existing channel cross-section and bed elevation except for minor bank grading at the point of the crossing.

C.2.1.9. Maintenance of existing channelized perennial streams less than 0.5 square miles of watershed size, i.e. those through and around roadsides and agricultural fields, and streams diverted for water supply purposes, provided:

- a) The maintenance work is conducted in a manner which minimizes or avoids any discharge of sediment or other pollutants to surface waters; and
- b) If the work is in association with agricultural lands, vegetated buffers as required under applicable Accepted Agricultural Practices (AAPs), Medium or Large Farm Operation Permits, and/or other applicable rules are maintained; and
- c) Erosional channels are appropriately stabilized with vegetative and/or structural treatments; and
- d) Excavated sediments are disposed appropriately; and
- e) Project improvements that move toward attainment of the Equilibrium Standard are implemented wherever feasible.

If the project is not covered under C.2.1 above, the Secretary should be notified in accordance with C.2.2. below.

Any person who may be unfamiliar with or unable to ensure their activity will be in compliance with the Equilibrium Standard, or meets the activity-specific criteria in C.2.1.1. – C.2.1.9., should contact an Agency River Management Engineer. Contact information is at:

<http://www.anr.state.vt.us/dec/waterq/rivers/htm/rvcontact.htm>. Failure to comply with the Equilibrium Standard in accordance with the requirements of this general permit may be cause for an enforcement action.

For any stream alteration activity authorized according to the non-reporting provisions of this General Permit, the Secretary waives 401 Water Quality Certification. This does not constitute a waiver of 401 Certifications that might be required under other applicable permit programs.

C.2.2. Reporting Activities that Require an Application – It is recommended that persons considering project proposals that may fall within the category of Reporting Activities described in this Section C.2.2. contact a Agency River Management Engineer to determine whether the project may be considered

a non-reporting activity under C.2.1. above. See:
http://www.anr.state.vt.us/dec/waterq/rivers/htm/rv_contact.htm

An application for an authorization under this general permit shall be submitted for the following categories of activities (as indicated in the Activities Table, page 11):

C.2.2.1. Activities in perennial streams with watershed areas less than 10.0 square miles:

- a) In a designated Outstanding Resource Water; or
- b) Do not meet the equilibrium standard in C.2.1.1; or
- c) Do not meet the activity-specific requirements in C.2.1.2. through C.2.1.8;

C.2.2.2. Maintenance of existing channelized perennial streams, i.e., those through and around roadsides and agricultural fields, and streams diverted for water supply purposes; with watershed areas:

- a) Less than 0.5 square miles, that does not meet the criteria specified in C.2.1.9.
- b) 0.5 square miles or greater, but less than 10.0 square miles, regardless of whether the criteria specified in C.2.1.9. are met; and

C.2.2.3. Any other Non-Exempt Activity on a stream with a watershed area 1.0 square miles or greater, but less than 10.0 square miles (see C.1. above for a list of Statutorily Exempt Activities). An example under this provision would be an activity meeting the equilibrium standard but not listed in C.2.1.2. – C.2.1.9. and is located on a perennial stream with a one to ten square mile watershed area.

C.2.3. Application Requirements for Reporting Activities – Prior to the initiation of any activity requiring authorization under this general permit, an application for authorization shall be submitted on a form provided by the Secretary and shall consist of, at a minimum:

- a) A location map, with a written description of the proposed project, landowner (required), and contractor(s) (if known) with contact information;
- b) A plan view, longitudinal profile, and at least one typical cross section; with
- c) Each drawing (not necessarily to scale) depicting both existing and proposed conditions; and
- d) A reporting fee (if required) if the project is located where the watershed size is greater than 1.0 square miles. See the reporting activity application form for information regarding the applicable application fee.

The applicant shall provide notice, on a form provided by the Secretary, to the clerk of the municipality in which the activity is located, to the local and regional planning commissions, and to the owners of land adjoining the site of the proposed activity. The applicant shall certify, on the notification form, that such notifications have been made and shall provide a copy to the Secretary. The Stream Alteration Reporting Activity application form is available at: www.vtwaterquality.org/rivers, or contact a River Management Engineer. See: http://www.anr.state.vt.us/dec/waterq/rivers/htm/rv_contact.htm. The Secretary may, upon review, require submittal of additional information necessary to evaluate the proposed activity and application.

C.2.4. Review of Application and Public Comment Period – Following receipt of confirmation by the applicant that notice of the application has been provided, as required under 10 VSA, §7503(b), the Secretary shall provide an opportunity of at least ten (10) working days for written comment regarding whether the application complies with the terms and conditions of this general permit. After consideration of the application and public comment and any other relevant information, the Secretary may grant an application for authorization under this general permit if:

C.2.4.1. The application is deemed complete;

C.2.4.2. The required notice of the application has been provided

C.2.4.3. The activity is eligible for coverage under the General Permit by being:

- a) In compliance with the requirements of 10 V.S.A. §1023; and
- b) Consistent with Section C.2.1.5. (c) above relating to aquatic organism passage; and
- c) Conducted in a manner which minimizes or avoids any discharge of sediment or other pollutants to surface waters in violation of the VT Water Quality Standards (Note: all reasonable means to avoid discharges should be taken during trout spawning periods before July 1 and after October 1).

A request for additional information will constitute a response from the Secretary. If, after amendment of an application, authorization by the Secretary is not possible, the applicant may submit an application for an individual permit.

D. Individual Stream Alteration Permits

An individual stream alteration permit shall be required for any activity that is:

- a) Not a statutorily Exempt Activity (as listed in C.1 above);
- b) Conducted in a stream with a watershed area of 10 square miles or greater; and
- c) Not otherwise authorized as a non-reporting activity in C.2.1.2. through C.2.1.8

An individual permit shall also be required for any project, if deemed necessary by the Secretary, pursuant to Part E.3.10. of this general permit.

The Secretary may, upon review, determine any application for an individual permit to constitute a de minimus activity consistent with the requirements of 10 VSA §1023(a); which may then proceed as a Non-Reporting Activity.

An individual permit application is available through an Agency River Management Engineer, or at: http://www.anr.state.vt.us/dec/waterq/rivers/docs/rv_streamalt-application.pdf.

Vermont Section 248 and Act 250 Criteria

Vermont Statutes: Title 10 Conservation and Development Part 5 Land Use and Development Chapter 151 State Land Use and Development Plans Subchapter 4 Permits § 6086. Issuance of permit; conditions and criteria.

Headwaters - A permit will be granted whenever it is demonstrated by the applicant that, in addition to all other applicable criteria, the development or subdivision will meet any applicable health and environmental conservation department regulation regarding reduction of the quality of the ground or surface waters flowing through or upon lands which are not devoted to intensive development, and which lands are:

- (i) headwaters of watersheds characterized by steep slopes and shallow soils; or
- (ii) drainage areas of 20 square miles or less; or

(iii) above 1,500 feet elevation; or

(iv) watersheds of public water supplies designated by the agency of natural resources; or

(v) areas supplying significant amounts of recharge waters to aquifers.

Floodways - A permit will be granted whenever it is demonstrated by the applicant that, in addition to all other applicable criteria:

(i) the development or subdivision of lands within a floodway will not restrict or divert the flow of flood waters, and endanger the health, safety and welfare of the public or of riparian owners during flooding; and

(ii) the development or subdivision of lands within a floodway fringe will not significantly increase the peak discharge of the river or stream within or downstream from the area of development and endanger the health, safety, or welfare of the public or riparian owners during flooding.

Streams - A permit will be granted whenever it is demonstrated by the applicant that, in addition to all other applicable criteria, the development or subdivision of lands on or adjacent to the banks of a stream will, whenever feasible, maintain the natural condition of the stream, and will not endanger the health, safety, or welfare of the public or of adjoining landowners.

Vermont Water Quality Standards

Section 1-03: Anti-Degradation Policy

A. General Policy

All waters shall be managed in accordance with these rules to protect, maintain, and improve water quality.

B. Determination of Existing Uses

1. General

Existing uses of waters and the level of water quality necessary to protect those existing uses shall be maintained and protected regardless of the water's classification. Determinations of what constitute existing uses of particular waters shall be made either during the basin planning process or on a case-by-case basis during consideration of an application. The use of waters to receive or transport discharges of waste shall not constitute an existing use for purposes of these rules. In making a determination of the existing uses to be protected and maintained under this section and all other sections of these rules, the Secretary shall consider at least the following factors:

a. Aquatic biota and wildlife that utilize or are present in the waters;

b. Habitat that supports existing aquatic biota, wildlife, or plant life;

- c. The use of the waters for recreation or fishing;
- d. The use of the water for water supply, or commercial activity that depends directly on the preservation of an existing high level of water quality; and
- e. with regarding to the factors considered under paragraphs (a) and (b) above, evidence of the use's ecological significance in the functioning of the ecosystem or evidence of the use's rarity.

C. Protection and Maintenance of High Quality Waters

1. Waters the existing quality of which exceeds any applicable water quality criteria provide important environmental, economic, social and other benefits to the people of the state. Except as provided in subsection 2 of this part, such waters shall be managed to maintain and protect the higher water quality and minimize risk to existing and designated uses. In all cases, the level of water quality necessary to maintain and protect all existing uses as well as applicable water quality criteria shall be maintained.
2. A limited reduction in the existing higher quality of such waters may be allowed only when it is shown that:
 - a. the adverse economic or social impacts on the people of the state specifically resulting from the maintenance of the higher quality of the waters would be substantial and widespread;
 - b. these adverse impacts would exceed the environmental, economic, social, and other benefits of maintaining the higher water quality; and
 - c. there shall be achieved the highest statutory and regulatory requirements for all new or existing point sources, and all cost effective and reasonable accepted agricultural practices and best management practices, as appropriate for nonpoint source control, consistent with state law.
3. To the extent any reduction in the quality of high quality waters is allowed, such reduction shall be limited to that which is necessary to comply with subsections C(2) above.

D. Protection of Outstanding Resource Waters

The Board may under 10 V.S.A. § 1424a designate certain waters as Outstanding Resource Waters. Where the Board so designates such waters because of their water quality values, their existing quality shall, at a minimum, be protected and maintained.

Vermont Statutes Title 10: Conservation and Development
Chapter 41: Regulation of Stream Flow

§ 1021. Alteration prohibited; exceptions

Subsection (a) effective until March 31, 2011; see also subsection (a) set out below.

(a) A person shall not change, alter or modify the course, current or cross-section of any watercourse with a drainage area greater than ten square miles at the location of the proposed change, alteration or modification, or of designated outstanding resource waters, within or along the boundaries of this state either by movement, fill, or by excavation of ten cubic yards or more in any year, unless authorized by the secretary.

Subsection (a) effective March 31, 2011; see also subsection (a) set out above.

(a) A person shall not change, alter, or modify the course, current, or cross-section of any watercourse or of designated outstanding resource waters, within or along the boundaries of this state either by movement, fill, or by excavation of ten cubic yards or more in any year, unless authorized by the secretary.

(b) This subchapter shall not apply to emergency protective measures necessary to preserve life or to prevent severe imminent damage to public or private property, or both. The protective measures shall be limited to the minimum amount necessary to remove imminent threats to life or property, shall have prior approval from a member of the municipal legislative body and shall be reported to the secretary by the legislative body within 72 hours after the onset of the emergency.

(c) No person shall remove gravel from any watercourse primarily for construction or for sale.

(d) Notwithstanding subsection (c) of this section, a riparian owner may remove up to 50 cubic yards of gravel per year from that portion of a watercourse running through or bordering on the owner's property, provided:

(1) the material shall be removed only for the owner's use on the owner's property;

(2) the material removed shall be above the waterline; and

(3) at least 72 hours prior to the removal of 10 cubic yards, or more, the landowner shall notify the secretary;

(4) however, if the portion of the watercourse in question has been designated as outstanding resource waters, then the riparian owner may so remove no more than 10 cubic yards of gravel per year, and must notify the secretary at least 72 hours prior to the removal of any gravel.

(e) This subchapter does not apply to dams subject to chapter 43 of this title nor to highways or bridges subject to 19 V.S.A. § 10(12).

(f) This subchapter shall not apply to accepted agricultural or silvicultural practices, as defined by the secretary of agriculture, food and markets, or the commissioner of forests, parks and recreation, respectively.

(g) Nothing in this chapter shall prohibit, in the normal use of land, the fording of or access to a watercourse by a person with the right or privilege to use the land.

(h)(1) Notwithstanding any other provisions of this section, recreational mineral prospectors:

(A) shall not operate suction dredges in any watercourse;

(B) may operate sluice boxes in any watercourse, provided:

(i) a request for approval to conduct mineral prospecting shall be filed with and approved by the secretary; and

(ii) mineral prospecting shall not be conducted on private land without landowner permission, or on state land without permission from the secretary.

(2) Hand panning prospecting techniques shall be exempt from this subchapter. (1965, No. 111, § 1, eff. June 22, 1965; amended 1969, No. 281 (Adj. Sess.), § 6; 1975, No. 150 (Adj. Sess.), § 2; 1981, No. 222 (Adj. Sess.), § 24; 1983, No. 193 (Adj. Sess.), § 4, eff. April 27, 1984; 1987, No. 67, § 4; 1997, No. 106 (Adj. Sess.), § 2, eff. April 27, 1998; 1999, No. 156 (Adj. Sess.), § 32, eff. May 29, 2000; 2003, No. 42, § 2, eff. May 27, 2003; 2009, No. 110 (Adj. Sess.), § 14, eff. March 31, 2011.)

Vermont Statutes Title 10: Conservation and Development

Chapter 111: Fish

§ 4607. Obstructing streams

(a) A person shall not unless authorized by the commissioner, prevent the passing of fish in a stream or the outlet or inlet of a natural or artificial pond on a public stream, by means of a rack, screen, weir or other obstruction, and shall comply with the terms of the notice provided in subsection (b) of this section.

(b) The commissioner may order such an obstruction removed by the person erecting the same or by the owner of the land on which it is located, by serving on such person or owner a written notice requiring the removal of such obstruction within ten days after service thereof. When such person fails to remove any such obstruction within the time required in such notice, the commissioner may remove the same and recover the expense thereof in a civil action on this section. (Added 1961, No. 119, § 1, eff. May 9, 1961.)

Recommended stream crossing references and other documents:

- **Vermont Fish and Wildlife – Stream Crossing Handbook**
- **Vermont Agency of Natural Resources – Guidelines for the Design of Stream/Road Crossings for Passage of Aquatic Organisms in Vermont**
- **Vermont Agency of Natural Resources – Riparian Buffers and Corridors Technical Papers**
- **Natural Resources Conservation Service – Conservation Practice Standards Fish Passage Code 396**

References

- Bates, K.K. and R. Kirn, 2009. Guidelines for the Design of Stream/Road Crossings for Passage of Aquatic Organisms in Vermont. Vermont Fish and Wildlife
- Dindorf, C. and K. Voznyuk. 2010. Temporary Stream, Wetland and Soft Soil Crossings. Minnesota Erosion Control Association
- NRCS (Natural Resources Conservation Service). 2006. Natural Resources Conservation Service Conservation Practice Standard Fish Passage (Mi) Code 396.
- Rosgen, D. 1996. Applied River Morphology. Wildlife Hydrology, Pagosa Springs, Colorado.
- UNH (University of New Hampshire). 2009. New Hampshire Stream Crossing Guidelines.
- USACE (United States Army Corp of Engineers). 2007. Department of the Army General Permit State of Vermont.
- USACE (United States Army Corp of Engineers). Ecosystem Management and Restoration Research Program. <http://el.erc.usace.army.mil/emrrp/>
- VTANR (Vermont Agency of Natural Resources). 2003. Vermont Stream Geomorphic Assessment Phase 3 Handbook: Survey Assessment - Field and Data Protocols.
- VTANR (Vermont Agency of Natural Resources). 2005. Guidance for Agency Act 250 and Section 248 Comments Regarding Riparian Buffers.
- VTANR (Vermont Agency of Natural Resources). 2005. Riparian Buffers and Corridors: Technical Papers.
- VTANR (Vermont Agency of Natural Resources). 2007. Vermont Stream Geomorphic Assessment Phase 1 Handbook: Watershed Assessment - Using Maps, Existing Data, and Windshield Surveys.
- VTANR (Vermont Agency of Natural Resources). 2009. Vermont Stream Geomorphic Assessment Phase 2 Handbook: Rapid Stream Assessment - Field Protocols.
- VTDEC (Vermont Department of Environmental Conservation). 2006 updated 2009. The Vermont Standards and Specifications for Erosion Prevention and Sediment Control.
- VTDEC (Vermont Department of Environmental Conservation). 2011. Stream Alteration General Permit.
- VTDEC (Vermont Department of Environmental Conservation), Regulatory Requirements for Stream Crossing Structures. VTDFPR and VT DEC (Vermont Department of Forest, Parks and Recreation and VT Department of Environmental Conservation). 2003. Timber Harvesting Stream Crossing Protocol.

VTFWD (Vermont Fish and Wildlife Department). Vermont Stream Crossing Handbook.

VTNRB (Vermont Natural Resources Board), Water Resource Panel. 2008. Vermont Water Quality Standards, Vt. Code R. 12 0004 052

Appendix 1:

Typical Stream Crossing Details

Mat Bridge Detail 1

Mat Bridge Detail 2

Mat Bridge Detail 3

Culvert Detail 1

Culvert Detail 2

VELCO ENVIRONMENTAL GUIDANCE MANUAL

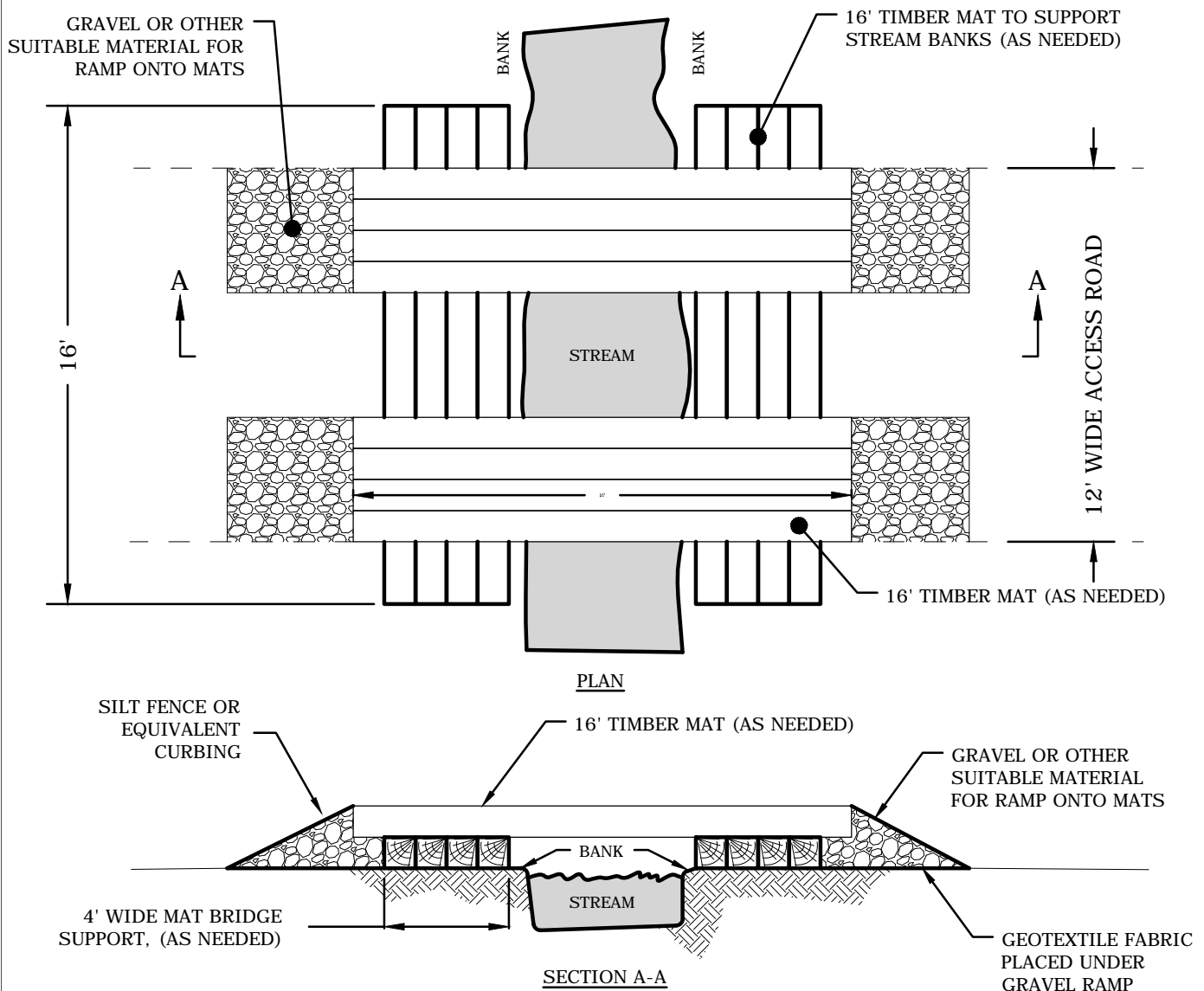

NOTES

1. DEPLOY EROSION CONTROLS AS NEEDED TO MINIMIZE EROSION.
2. PERFORM ROUTINE INSPECTION TO INCLUDE REMOVAL OF LOOSE SOIL TRACKED ONTO BRIDGE BY EQUIPMENT AND INSPECTION OF STREAM BANKS FOR STABILITY.
3. MATS SHALL BE POSITIONED TO RETAIN THE NATURAL STREAM CHARACTERISTICS.
4. MATS LAID PERPENDICULAR TO THE STREAM CAN BE SUBSTITUTED WITH PRE-FABRICATED BRIDGE STRUCTURES AS SPAN LENGTHS DICTATE OR AT THE PREFERENCE OF THE CONTRACTOR.



VERMONT ELECTRIC POWER COMPANY, INC.
366 PINNACLE RIDGE ROAD
RUTLAND, VERMONT 05701

TEMP. STREAM CROSSING BRIDGE - TYPICAL

DATE: 7/11/11

REV:

REF:

WS-2

VELCO ENVIRONMENTAL GUIDANCE MANUAL

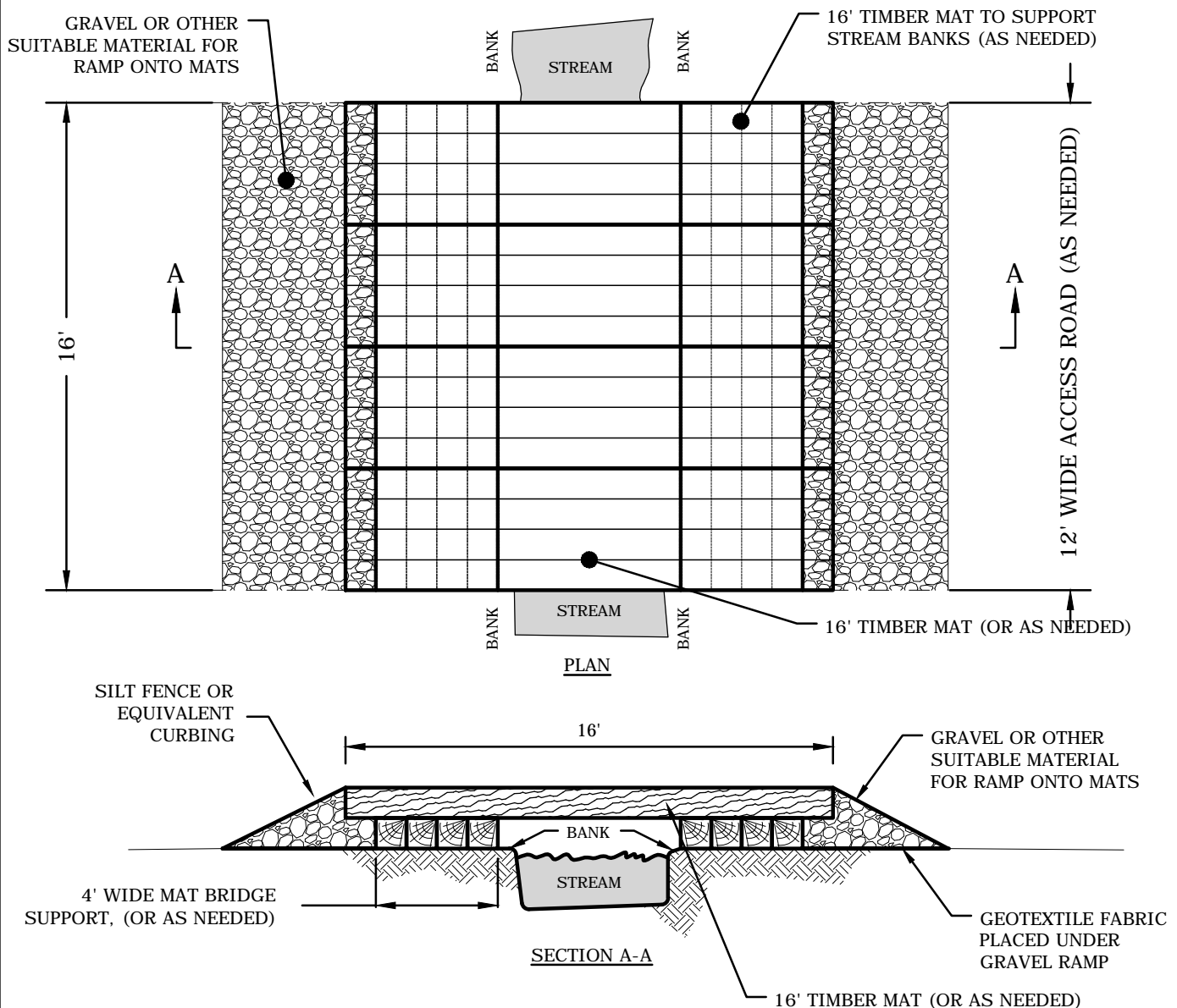

NOTES

1. DEPLOY EROSION CONTROLS AS NEEDED TO MINIMIZE EROSION.
2. PERFORM ROUTINE INSPECTION TO INCLUDE REMOVAL OF LOOSE SOIL TRACKED ONTO BRIDGE BY EQUIPMENT AND INSPECTION OF STREAM BANKS FOR STABILITY.
3. MATS SHALL BE POSITIONED TO RETAIN THE NATURAL STREAM CHARACTERISTICS.
4. MATS LAID PERPENDICULAR TO THE STREAM CAN BE SUBSTITUTED WITH PRE-FABRICATED BRIDGE STRUCTURES AS SPAN LENGTHS DICTATE OR AT THE PREFERENCE OF THE CONTRACTOR.



VERMONT ELECTRIC POWER COMPANY, INC.
366 PINNACLE RIDGE ROAD
RUTLAND, VERMONT 05701

TEMP. STREAM CROSSING
BRIDGE - ALT #1

DATE: 7/11/11

REV:

REF:

WS-2.1

VELCO ENVIRONMENTAL GUIDANCE MANUAL

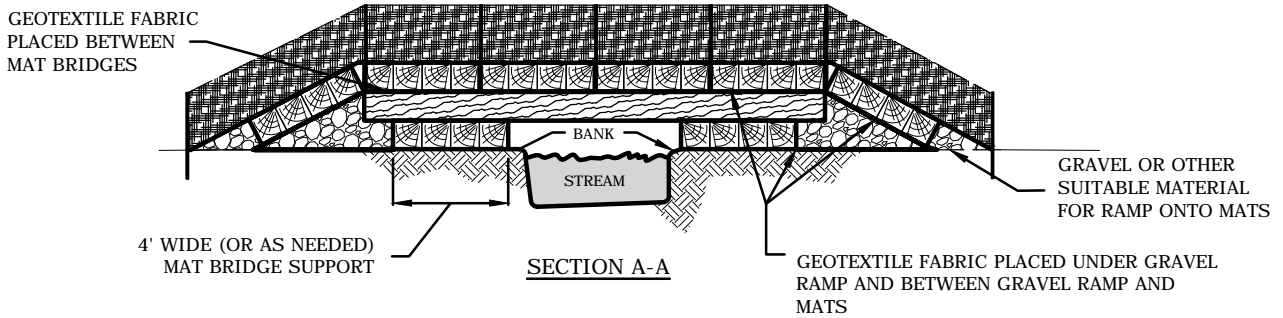
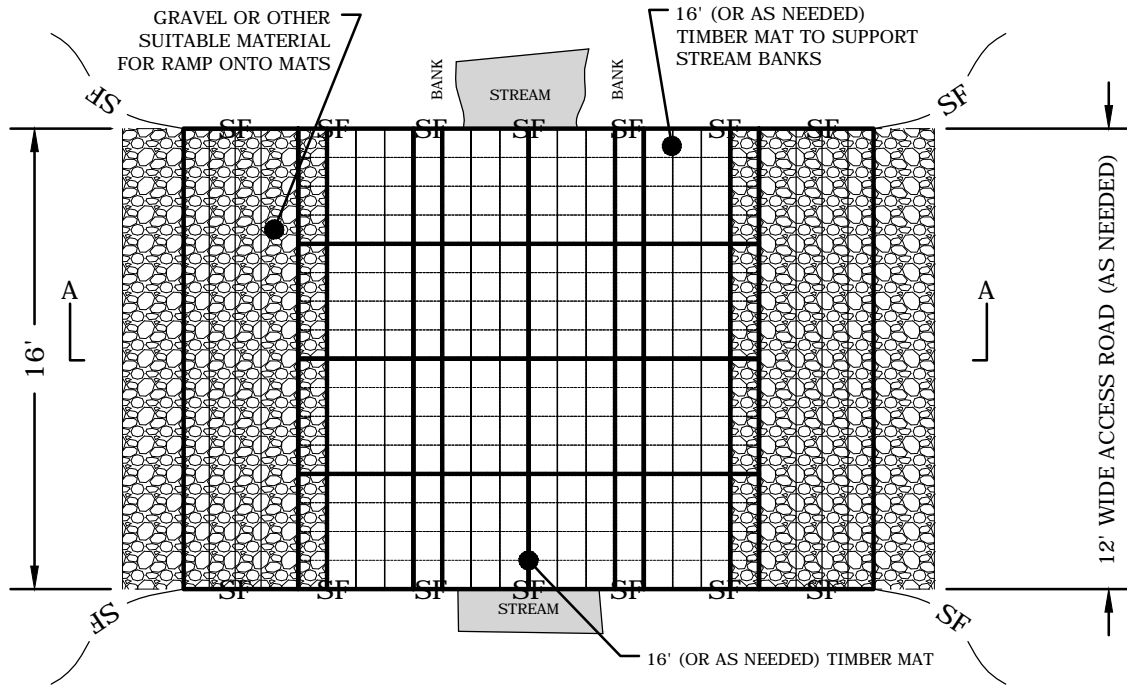

NOTES

1. DEPLOY EROSION CONTROLS AS NEEDED TO MINIMIZE EROSION.
2. PERFORM ROUTINE INSPECTION TO INCLUDE REMOVAL OF LOOSE SOIL TRACKED ONTO BRIDGE BY EQUIPMENT AND INSPECTION OF STREAM BANKS FOR STABILITY.
3. MATS SHALL BE POSITIONED TO RETAIN THE NATURAL STREAM CHARACTERISTICS.
4. MATS LAID PERPENDICULAR TO THE STREAM CAN BE SUBSTITUTED WITH PRE-FABRICATED BRIDGE STRUCTURES AS SPAN LENGTHS DICTATE OR AT THE PREFERENCE OF THE CONTRACTOR.

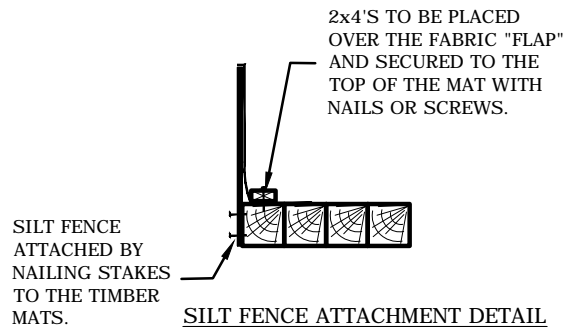

VERMONT ELECTRIC POWER COMPANY, INC.
366 PINNACLE RIDGE ROAD
RUTLAND, VERMONT 05701

TEMP. STREAM CROSSING
BRIDGE - ALT #2

DATE: 7/11/11

REV:

REF:

WS-2.2

VELCO ENVIRONMENTAL GUIDANCE MANUAL

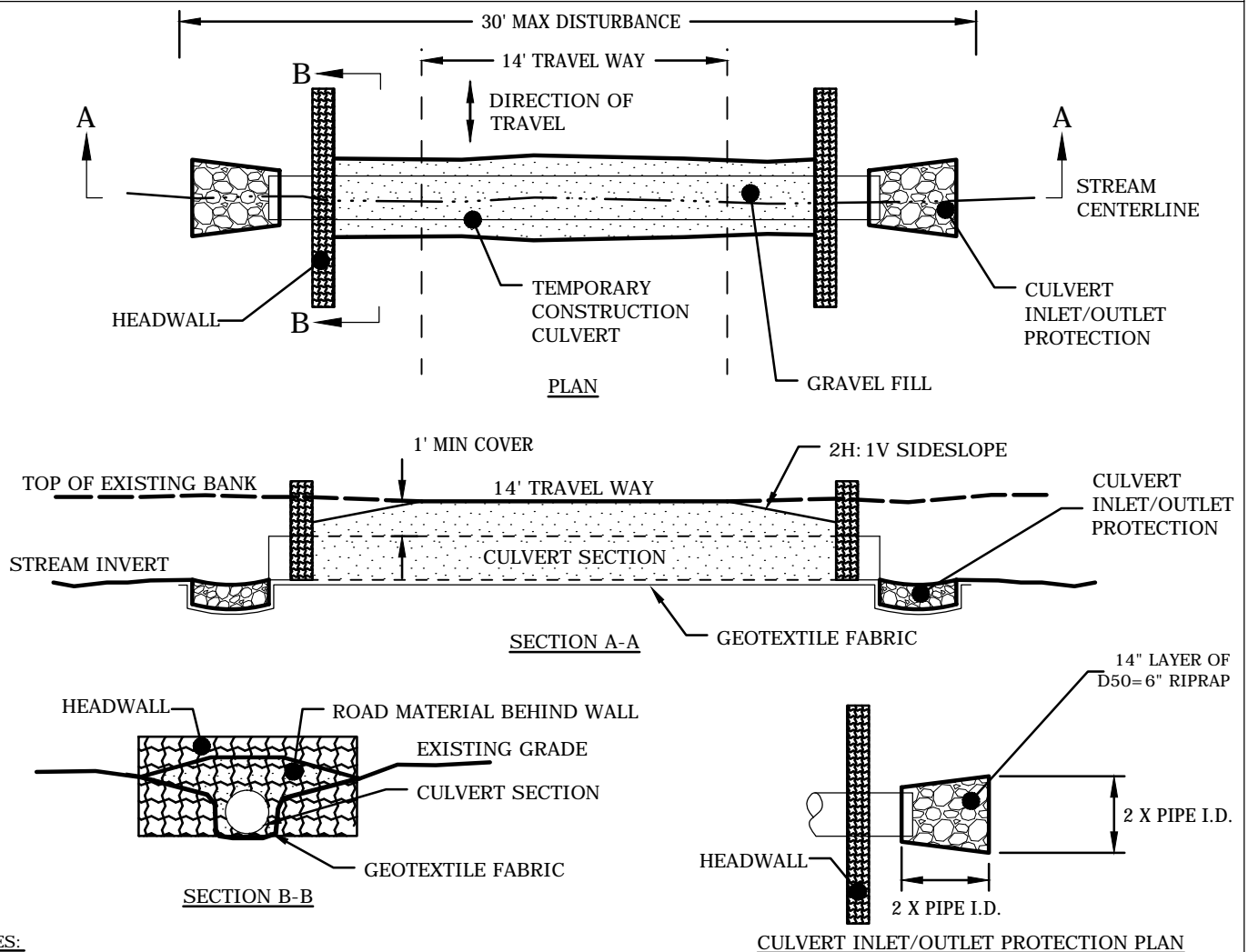

NOTES:

1. **CULVERT SIZE:** THE CROSS SECTIONAL AREA OF THE CULVERT PIPE SHALL BE THE LARGEST PIPE DIAMETER EQUAL TO THE UNDISTURBED CROSS SECTIONAL AREA OF THE BANK FULL CONDITION OF THE STREAM. IT SHOULD FIT INTO THE EXISTING CHANNEL WITHOUT EXCAVATION OF THE WATERWAY CHANNEL OR MAJOR APPROACH FILLS. IF A CHANNEL WIDTH EXCEEDS 3 FEET, ADDITIONAL PIPES MAY BE USED UNTIL THE CROSS SECTIONAL AREA OF THE PIPES APPROACHES THE EXISTING CHANNEL. THE MINIMUM CULVERT SIZE SHALL BE AN 18-INCH DIAMETER PIPE.
2. **CULVERT LENGTH:** THE CULVERTS SHALL EXTEND A MINIMUM OF ONE FOOT BEYOND THE UPSTREAM AND DOWNSTREAM TOE OF THE AGGREGATE PLACED AROUND THE CULVERT. IN NO CASE SHALL THE CULVERT EXCEED THE WIDTH NEEDED TO ACCESS THE WORK LOCATION WITH A SINGLE LANE.
3. THE INVERT ELEVATIONS OF THE CULVERT SHALL BE INSTALLED AT OR BELOW THE NATURAL STREAMBED GRADE TO MINIMIZE INTERFERENCE WITH FISH MIGRATION.
4. THE CULVERT SHALL BE COVERED WITH A MINIMUM ONE FOOT OF AGGREGATE. IF MULTIPLE CULVERTS ARE USED, THEY SHALL BE SEPARATED BY AT LEAST 12 INCHES OF COMPACTED AGGREGATE FILL.
5. TEMPORARY INLET AND OUTLET PROTECTION IS TO BE INSTALLED AS DETAILED.
6. GEOTEXTILE FABRIC SHALL BE PLACED ON THE STREAMBED AND STREAMBANKS PRIOR TO PLACEMENT OF THE PIPE AND AGGREGATE. THE FABRIC SHALL COVER THE STREAMBED AND EXTEND A MINIMUM SIX INCHES AND A MAXIMUM ONE-FOOT BEYOND THE END OF THE CULVERT AND BEDDING MATERIAL.
7. **HEADWALL NOTE:** THE CULVERT HEADWALL SHALL BE CONSTRUCTED IN A MANNER THAT PRESERVES THE ORIGINAL STREAM OR DRAINAGE CHANNEL, AVOIDS IMPACTS TO REGULATED FEATURES (I.E WETLANDS, STREAMS), AND PRESERVES ROAD SHOULDER INTEGRITY AS IT RELATES TO STORMWATER EROSION AND THE ALLOWABLE ROAD WIDTH. HEADWALLS SHALL CONSIST OF EITHER SUITABLE, LOCAL MATERIALS (I.E. BOULDERS, LOGS) OR APPROVED PRECAST CONCRETE BLOCKS, GABIONS, OR STONE.



VERMONT ELECTRIC POWER COMPANY, INC.
366 PINNACLE RIDGE ROAD
RUTLAND, VERMONT 05701

TEMPORARY CULVERT WITH HEAD WALL

DATE: 7/11/11

REV:

REF:

WS-4.1

VELCO ENVIRONMENTAL GUIDANCE MANUAL

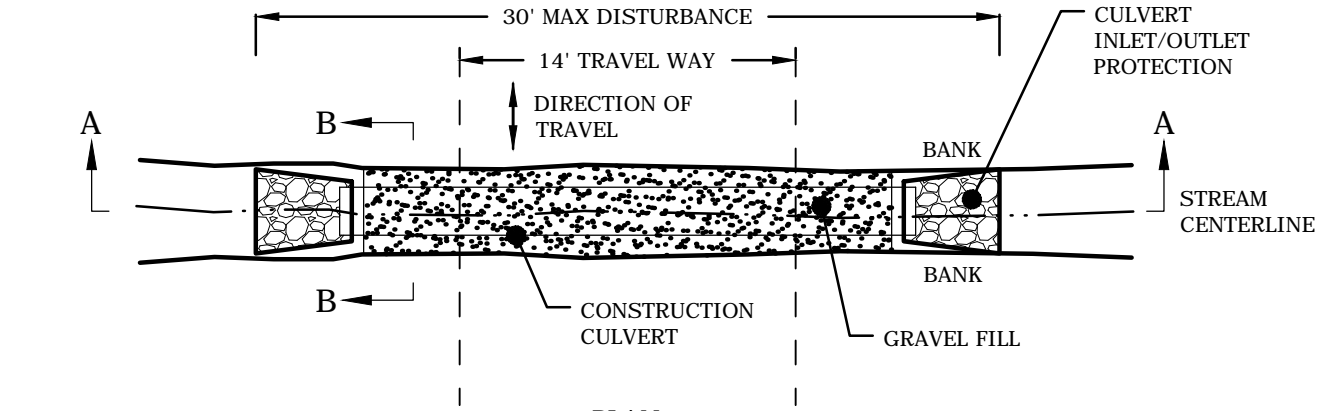

PLAN

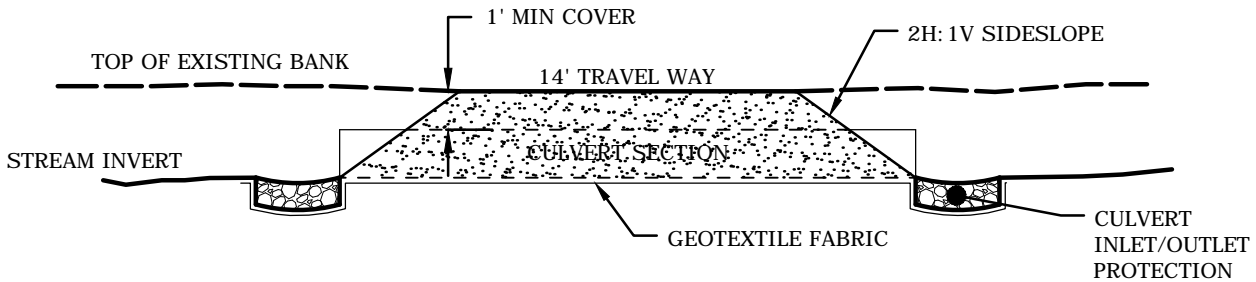

SECTION A-A

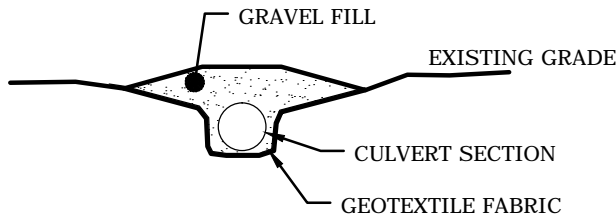

SECTION B-B

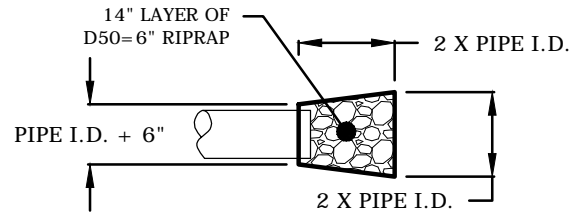

CULVERT INLET/OUTLET PROTECTION PLAN

NOTES:

1. CULVERT SIZE: THE CROSS SECTIONAL AREA OF THE CULVERT PIPE SHALL BE THE LARGEST PIPE DIAMETER EQUAL TO THE UNDISTURBED CROSS SECTIONAL AREA OF THE BANK FULL CONDITION OF THE STREAM. IT SHOULD FIT INTO THE EXISTING CHANNEL WITHOUT EXCAVATION OF THE WATERWAY CHANNEL OR MAJOR APPROACH FILLS. IF A CHANNEL WIDTH EXCEEDS 3 FEET, ADDITIONAL PIPES MAY BE USED UNTIL THE CROSS SECTIONAL AREA OF THE PIPES APPROACHES THE EXISTING CHANNEL. THE MINIMUM CULVERT SIZE SHALL BE AN 18-INCH DIAMETER PIPE.
2. CULVERT LENGTH: THE CULVERTS SHALL EXTEND A MINIMUM OF ONE FOOT BEYOND THE UPSTREAM AND DOWNSTREAM TOE OF THE AGGREGATE PLACED AROUND THE CULVERT. IN NO CASE SHALL THE CULVERT EXCEED THE WIDTH NEEDED TO ACCESS THE WORK LOCATION WITH A SINGLE LANE.
3. THE INVERT ELEVATIONS OF THE CULVERT SHALL BE INSTALLED AT OR BELOW THE NATURAL STREAMBED GRADE TO MINIMIZE INTERFERENCE WITH FISH MIGRATION.
4. THE CULVERT SHALL BE COVERED WITH A MINIMUM ONE FOOT OF AGGREGATE. IF MULTIPLE CULVERTS ARE USED, THEY SHALL BE SEPARATED BY AT LEAST 12 INCHES OF COMPACTED AGGREGATE FILL.
5. INLET AND OUTLET PROTECTION IS TO BE INSTALLED AS DETAILED.
6. GEOTEXTILE FABRIC SHALL BE PLACED ON THE STREAMBED AND STREAMBANKS PRIOR TO PLACEMENT OF THE PIPE AND AGGREGATE. THE FABRIC SHALL COVER THE STREAMBED AND EXTEND A MINIMUM SIX INCHES AND A MAXIMUM ONE-FOOT BEYOND THE END OF THE CULVERT AND BEDDING MATERIAL.



VERMONT ELECTRIC POWER COMPANY, INC.
366 PINNACLE RIDGE ROAD
RUTLAND, VERMONT 05701

CULVERT
TYPICAL

DATE: 7/11/11

REV:

REF:

WS-4.2

INTEGRATED VEGETATION MANAGEMENT STRATEGIES FOR INDIANA BAT HABITAT IN VERMONT ELECTRIC TRANSMISSION LINE RIGHTS OF WAY

The Indiana bat is a state- and federally-listed endangered species in Vermont. The availability of suitable habitat in areas used by bats is of primary importance to the management strategies of the Vermont Fish and Wildlife Department (VFWD) and the U.S. Fish and Wildlife Service (USFWS). Vegetation management activities associated with the maintenance of electric transmission lines present both challenges and opportunities for the study and effective management of bat habitat. Central Vermont Public Service Corporation (CVPS) and the Vermont Electric Power Company (VELCO) maintain electric transmission lines in areas known to be used by Indiana bats. CVPS and VELCO manage the associated rights of way using the principles of Integrated Vegetation Management through the adoption, periodic update, and continuous application of vegetation management plans.

Issues of concern mainly relate to the removal of trees used by bats as roosting sites, and the loss of bat habitat by the removal of all woody vegetation within the cleared right of way. The removal of trees containing roosting bats can result in the killing of individual animals. The creation of excessively wide cleared spaces through conversion of forest cover to an area containing only herbaceous plants may create an effective barrier to the movement of bats. The following best management practices have been designed to minimize impacts in those areas of Vermont known to contain Indiana bats, and to make use of the Integrated Vegetation Management programs employed by Vermont electric utilities to manage and where possible enhance habitat quality.

In order to remain viable as habitat for Indiana bats, an area must contain both a sufficient number of roosting trees and acreage of contiguous and interconnected forest cover for foraging. Research suggests that Indiana bats will not cross openings greater than 50 - 100 feet in width that lack such cover. To readily travel across such openings, Indiana bats require cover in the form of woody vegetation approximately 6-10 feet in height. Therefore, in order to avoid hindering bat movement, vegetation management activities should strive to maintain existing low-growing woody vegetation in the right of way.

In some cases, slight modifications or additions to normal vegetation management practices may improve both the quantity and quality of Indiana bat habitat. Due to the location, quantity, and continuous management of electric transmission rights of way, the protection and enhancement techniques can provide uniquely valuable sites for monitoring and study of Indiana bats and Indiana bat habitat in Vermont. VFWD biologists, through careful cooperation with utility foresters, can design site-specific management and monitoring programs to assess the potential positive and negative effects of utility operations on bat survival.

To further the goals of state and federal regulations related to protection of threatened and endangered species in Vermont, and to take advantage of the unique opportunities presented by ongoing Integrated Vegetation Management programs within existing and future electric transmission rights of way, CVPS and VELCO agree to implement the following Best Management Practices (BMPs) in select identified locations that are likely to provide the maximum benefit for Indiana bat survival and study as determined by VFWD, avoid adverse impacts to Indiana bats, and be compatible with maintenance and reliability standards as determined by the utilities. It is recognized by all parties that implementation of these BMPs may be affected or restricted by emergency restoration activities, imminent threats to reliability, state and federal reliability standards, and easement or other property restrictions. CVPS and VELCO agree to implement the BMPs within the legitimate confines of such restrictions, and to act in good faith to minimize the impacts of emergency repair and restoration efforts on their successful and continuing application.

BEST MANAGEMENT PRACTICES

The following practices are grouped according to their intended purpose, and listed in order of preferred use. Where the application of a particular practice is not practicable due to physical, property, reliability, or regulatory constraints, utility managers will seek to use an alternative listed practice.

Protection of roosting Indiana bats during construction projects that involve the clearing of trees

The simplest and most effective method of protecting roosting individuals during clearing activities is to avoid the felling or removal of trees containing roosting Indiana bats. This can be accomplished through time-of-year restrictions that limit the removal of large trees to the period of time when Indiana bats are hibernating in caves and mines, or by site-specific assessments where such restrictions are not practical.

In order to avoid the taking of roosting individuals during construction projects:

- Perform tree removals only during the period between October 15 and April 15. If required for access, trees less than 8 inches diameter at breast height (dbh) may be removed and/or trimmed as needed, taking care to protect any larger trees.
- Where larger trees must be removed outside the allowed time period, the area of clearing should be assessed for the presence of potential roost trees (trees of suitable size, species, and height with peeling or loose bark capable of providing shelter for roosting bats) by a CVPS or VELCO employee trained in identifying such trees by the VFWD. If necessary, VFWD biologists may assist in identifying potential roost trees on the project site. Potential roost trees should be marked prior to the commencement of clearing activities, and care must be taken to protect these trees and potentially roosting bats from damage during clearing activities.

- Potential roost trees protected during initial clearing activities may subsequently be removed as necessary, only during the period between October 15 and April 15. It is anticipated that sufficient roost trees are available within 2.5 miles of the project site to offset the loss of these potential, yet unconfirmed, roost trees.

Protection of foraging habitat and bat crossings during construction projects

In order to maintain existing foraging areas and adequate cover for bats to move across a maintained right of way, the following steps should be taken during construction projects:

- When available, compatible woody species should be retained where possible, with the following exceptions as appropriate in the judgment of the utility:
 - Areas needed to provide clearance for safe and efficient access; and
 - the “wire zone,” which for the purposes of this plan is an area, centered on the pole structures and under the electrical conductors/communication wires, and which must be maintained free of woody vegetation for reliability and safety.
 - The removal of “danger trees” as those trees represent a strike hazard to the line due to defects and/or growth characteristics.
- Efforts to retain existing compatible woody vegetation should focus on areas where it can provide continuous cover at least 25 feet in width and at least 6 – 10 feet in height between the edges of the cleared right of way. Areas containing streams and wetlands are particularly valuable and should take precedence over upland areas where practicable.

Creation of foraging habitat and bat crossings during construction and maintenance projects

For certain construction projects VFWD may determine that it is appropriate to create new crossings, or enhance existing crossings, through the use of strategic plantings. In addition, utilities and VFWD may agree to the creation of new crossings within existing cleared rights of way. When creating new foraging habitat and bat crossings:

- Encourage existing compatible woody vegetation to create crossings, the length of which shall extend to both edges of the cleared corridor, with the exception of the “wire zone” as appropriate in the judgment of the utility.
- If existing vegetation is not suitable, crossings will be created by planting suitable woody vegetation, the length of which shall extend to both edges of the cleared corridor, with the exception of the “wire zone” as appropriate in the judgment of the utility.
 - Plantings should consist of compatible woody species suitable for the site and consistent with maintenance requirements and reliability standards, and will be spaced in a manner to provide continuous cover between the edges of the right of way at maturity. Each crossing should be at least 25 feet in width and be maintained at heights no less than between 6 – 10 feet. When feasible, crossings should be located along streams and wetlands.
- Crossings should be maintained as described in this plan until VFWD determines that they are no longer necessary for the protection of Indiana bats (within the limits of above-listed constraints associated with emergency work or routine vegetative management work to ensure compliance with reliability standards).

Creation/enhancement of roosting habitat during construction and maintenance projects

- For certain construction projects – particularly those involving new or expanded rights of way that may remove potential roost trees – VFWD may determine that it is appropriate to create or enhance new potential roosting sites through innovative management techniques. The utilities and VFWD may agree to the creation of new potential roosting sites within and along existing cleared rights of way. Creation of potential roost trees will generally be accomplished through the removal of crowns and limbs from identified trees along the outer edges of the right of way, encouraging the gradual creation of roosting cover as the trees die and bark begins to peel away. In addition, enhancement of potential roost trees can be accomplished through the “daylighting” of existing potential roost trees by removing adjacent trees. The daylighting practice is intended to increase solar radiation on the potential roost tree. Daylighting may require additional landowner permissions if tree removals are outside utility easements or beyond the scope of normal clearing and danger tree removal.

When creating potential roost trees:

- Roost tree candidates of appropriate diameters, species, and solar exposure should be identified and marked prior to commencement of clearing or widening activities.
- In the areas of roost tree creation, clearing and widening activities should begin with the removal of limbs and crowns, and/or girdling as appropriate. Trunks of marked trees should be left in place and cut to a height (i.e., no less than 10 – 12 feet) that allows and encourages use by roosting bats once the bark begins to separate from the wood, but in no case may the retained trunk be left at a height that would allow contact with wires, guys or poles, or blockage of access in the event of trunk failure. Trunks should be double girdled as appropriate to ensure that the tree dies and sheds the bark.

When enhancing (i.e., daylighting) potential roost trees (with landowner permission as required):

- Existing potential roost trees of appropriate diameters and species should be identified and marked prior to commencement of clearing or widening activities.

- Create small openings (on as many as three sides) adjacent to identified potential roost trees, leaving adequate canopy cover within 20 feet for bats to emerge into forest cover.

Ongoing research and monitoring of retained and newly-created habitat

CVPS and VELCO shall allow VFWD reasonable access within their rights of way to conduct scientific studies within habitat management areas (subject to any additional landowner or other permissions that may be required). Landowner approvals shall be obtained by the VFWD in coordination with the utility. Utility activities may require temporary interruption of studies and/or alterations of mitigation plantings. Disruptions shall be kept to the minimum required. CVPS and VELCO shall work with VFWD to re-establish ongoing research activities following necessary disruptions.

DATED at RUTLAND, VERMONT this 10th DAY of JUNE, 2011

VERMONT FISH AND WILDLIFE DEPARTMENT

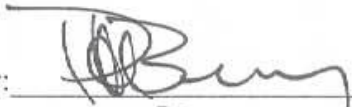
By: 
Print Name: PATRICK A BERRY
Title: Commissioner VT Fish & Wildlife Dept

CENTRAL VERMONT PUBLIC SERVICE CORPORATION

By: 
Print Name: TIMOTHY UPTON
Title: MGR. ENVIRONMENTAL AFFAIRS

VERMONT ELECTRIC POWER COMPANY

By: 
Print Name: BRIAN CONNAUGHTON
Title: ENVIRONMENTAL TEAM LEAD

